



ABSOLUTA®
3.00



EN50131

Expandable Hybrid Control Panel



ABSOLUTA

www.bentelsecurity.com
<https://itunes.apple.com>
<https://play.google.com/store>



Installer Manual

Default Installer PIN: (A)0104



**BENTEL®
SECURITY**

A Tyco International Company

Legacy...

Design...

Power...

Always use the most recently **BOSS** Console Software to program the **ABSOLUTA**.

Installation of the system must be carried out strictly in accordance with the instructions described in this manual, and in compliance with the local laws and bylaws in force.

The GSM Module **ABS-GSM** shall be installed by Service Persons only (service person is defined as a person having the appropriate technical training and experience necessary to be aware of hazards to which that person may be exposed in performing a task and of measures to minimize the risks to that person or other persons).

The GSM Module **ABS-GSM** shall be installed and used within an environment that provides the pollution degree max 2, over voltages category II, in non-hazardous, indoor locations only.

All instructions specified within this manual must be observed.

The **ABSOLUTA** Control Panels have been designed and manufactured to the highest standards of quality and performance.

The **ABSOLUTA** Control Panels have no user-changeable components, therefore, they should be serviced by authorized personnel only.

BENTEL SECURITY does not assume responsibility for damage arising from improper application or use.

The manufacturer recommends that the installed system should be completely tested at least once a month.

Hereby, BENTEL SECURITY, declares that **ABSOLUTA** Control Panels comply with the essential requirements and other relevant provisions of Directive:

2006/95/EC The Low Voltage Directive
2004/108/EC The Electromagnetic Compatibility Directive
99/55/EC The R&TTE Directive

This panel complies with **EN50131-1: 2008**, **EN50131-3: 2009** and **EN50131-6: 2008**

MAINTENANCE

Please verify the correct operation of security system at least once a month.

Periodically, perform the steps below.

- Remove dust accumulation on the panel container, with a damp cloth without use any type of solvent.
 - Check the status of the connections and wires.
 - Check inside the panel there are no foreign bodies.
- For other security-system devices, such as smoke detectors, infrared and microwave detectors, and inertial detectors, refer to the instructions for maintenance and testing.

RECYCLING INFORMATION

BENTEL SECURITY recommends that customers dispose of their used equipments (panels, detectors, sirens, and other devices) in an environmentally sound manner. Potential methods include reuse of parts or whole products and recycling of products, components, and/or materials.

For specific information see: <http://www.bentelsecurity.com/index.php?o=environmental>



WASTE ELECTRICAL AND ELECTRONIC EQUIPMENT (WEEE) DIRECTIVE

■ In the European Union, this label indicates that this product should NOT be disposed of with household waste. It should be deposited at an appropriate facility to enable recovery and recycling.

For specific information see: <http://www.bentelsecurity.com/index.php?o=environmental>

BENTEL SECURITY srl. reserves the right to change the technical specifications of this product without prior notice.

TABLE OF CONTENTS

INTRODUCTION	5	PROGRAMMING FROM THE PC	35
About the Control Panel	5	<i>Options with requirements</i>	35
Features	6	<i>Minimum system requirements</i>	35
<i>Common Features for all versions</i>	6	Configuration	36
<i>ABSOLUTA 16 features</i>	7	<i>Keypads</i>	36
<i>ABSOLUTA 42 features</i>	7	<i>Expander In</i>	37
<i>ABSOLUTA 104 features</i>	7	<i>Expander Out</i>	37
Control Panel versions	8	<i>Key Readers</i>	37
<i>The boxes</i>	8	<i>Power station</i>	37
<i>The Main Boards</i>	8	<i>Wireless Module</i>	39
<i>The Power Supplies</i>	8	Zones	39
<i>The Accessories</i>	8	Partitions	44
<i>Plug-In Modules</i>	8	Phonebook	45
Compatible items	9	<i>Audio Session</i>	46
Access Levels for panel management	11	<i>Priority</i>	46
Updates	11	Outputs	47
2.10	11	Voice Messages	48
3:00	11	Options	49
Technical Specifications	12	<i>General</i>	49
		<i>Time Options</i>	51
		<i>Received Call Options</i>	51
		<i>Phone Options</i>	52
		<i>Advanced Call Options</i>	54
		<i>EN50131</i>	54
		Events and Actions	54
		<i>Outputs</i>	54
		<i>Telephone</i>	54
		<i>Voice Messages</i>	54
		<i>Telemonitoring</i>	55
		<i>Restore</i>	55
		<i>Call All</i>	56
		<i>SMS</i>	56
		<i>Event Description</i>	56
		<i>Remote Command Events</i>	56
		<i>Caller ID over GSM events</i>	57
		<i>Default settings</i>	57
		Codes and Keys: User (PINs)	63
		Codes and Keys: Keys	64
		Codes and Keys: Keyfobs	65
		Event Schedule	66
		<i>Time table</i>	66
		<i>Partitions Event Editor</i>	66
		<i>Perpetual Calendar</i>	66
		Timers	67
		<i>Time table</i>	67
		<i>Timer Event Editor</i>	67
		<i>Perpetual Calendar</i>	67
		GSM	67
		<i>Pay As You Go</i>	68
		<i>App/BOSS Cellular Communication</i>	68
		<i>Cellular</i>	68
		<i>Disabling event transmission to the receivers</i>	69
		SMS Messages	70
		Downloading/Uploading	70
		<i>Connecting the Control Panel to the PC</i>	70
		<i>How Downloading/Uploading the Options</i>	71
IDENTIFICATION OF PARTS	13		
MOUNTING THE COMPONENTS	17		
Mounting the Metal Box	17		
Mounting the Plastic Box	18		
Installing the GSM Module	20		
INSTALLING	21		
Mounting the Control Panel	21		
Mounting the BPI Peripherals	21		
Terminals	21		
Wiring	23		
Connecting BPI Bus Devices	23		
<i>BPI bus Wiring Limitations</i>	24		
Connecting Detectors	24		
<i>Connecting Motion Detectors</i>	25		
<i>Connecting Roller-Blind and Vibration Detectors</i>	26		
<i>Connecting Fire Detectors</i>	27		
Connecting Alarm Signalling Devices	28		
<i>Supervised Output</i>	29		
Connecting Tamper Terminals	29		
Connecting the Telephone Line	30		
Connecting the AS100 Audio Station	31		
Power Supply	31		
<i>Power connection</i>	32		
<i>Power disconnection</i>	32		
<i>Auto-configuration (Wizard setup)</i>	32		
<i>Thermal Probe</i>	34		
Hardware Default	34		

KEYPAD OPERATIONS	73
Using the keypad	73
Access to the operations	74
Quit from the Operations	76
1.1) Zone Test	77
1.2) Output Test	78
1.3) Changing the PIN	78
1.4) Firmware Upgrade by an USB key	79
1.6) Modify the LCD Keypad language	79
1.7) Enabling Level 4 access	80
1.8) Clear Faults and Tamperers	80
1.9) Option Programming by Keypad	81
Zones	81
Partition	81
User PINs	82
Keys	82
WLS Keys	82
System	82
Key Reader	82
Keypad	82
2.1) Voice Message Recording	83
2.2) BPI Device enrolling	83
2.3) Wireless Device enrolling	84
2.4) Key enrolling	85
2.5) Message Download/Upload via USB Key	85
2.6) Option Download/Upload via USB Key	86
2.7) Factory Default	86
2.8) Telephone Communicator	87
2.9) Key Disabling/Enabling	87
3.1) View Logger	88
3.2) View the Firmware Version	88
3.3) View Zone Status and Zone Bypassing	89
3.4) View GSM Module Status	90

APPENDIX	93
Quick guide for the LCD Keypad menu	93
Zone Automapping	93
Reporting Formats	94
Contact ID	94
SIA	94
Wireless Receivers	97
Identification of Parts	97
Choosing a Mounting Location	97
Mounting the Receiver	97
Connecting the Receiver	97
Technical Specifications	97
Broadcasting of the M-Touch Keypad Labels	98

About the Control Panel

The full-featured ABSOLUTA security systems have been especially designed to satisfy all security needs, from residential to advanced industrial applications.

The objective of the ABSOLUTA is to make end-user operation simple and help the Installer improve efficiency. This is achieved by reduced complexity software and firmware, and remote programming and diagnostic facilities.

This system provides impressive application flexibility and many interesting features such as monitoring facilities and telephone access.

The ABSOLUTA range of panels is composed of three main models based on a common platform.

ABSOLUTA 16 Expandable up to 16 hardwired zones or 32 wireless zones. This Control Panel is dedicated to the basic applications for residential and small commercial sectors.

ABSOLUTA 42 Expandable up to 42 hardwired zones. This panel is dedicated to the middle-high level applications for the residential sector and to the middle level installation for the Commercial/Enterprise sector.

ABSOLUTA 104 Expandable up to 104 zones. This panel is dedicated to the high level applications for the residential sector and to the middle-high level installation for the Commercial/Enterprise sector.

Partitions ABSOLUTA manages independent Partitions — all with Stay/Away control (8 Partitions for **ABSOLUTA 16** and **ABSOLUTA 42**; 16 Partitions for **ABSOLUTA 104**). Each Partition (group of zones) can be programmed with its own Entry/Exit and Auto-Arm/Disarm Times, etc., and can be controlled by digital Keys/Cards, Codes and/or Input zones.

Events and Actions ABSOLUTA manages about 2000 events. The factory default settings have been purpose programmed to require few or no changes for standard applications. However, the programming flexibility of the Events and Actions (Output, Digital communicator and Voice Dialler Actions) will allow you to fully customize the system.

Communications The Communicator manages 32 telephone numbers for vocal communications and SMS messages (through the optional GSM Module, the **ABS-GSM**) and digital communications to Central Stations. Each Communicator number can have its own Account Code and Reporting format (usually assigned by the Central station).

The **BOSS** Software and a **standard** modem (such as the BENTEL **BLUM03**, provided upon request) and / or the optional GSM Module, the **ABS-GSM**, reduce on-site time to a minimum by allowing you to provide **Teleservice** (on-line Customer enquiry and assistance facilities).

The **Teleservice** function can also be used for uploading, downloading and diagnosis. Up to 1 telephone numbers can be assigned to this function.

Voice Messages The ABSOLUTA manages **206** recordable Voice Messages for the Voice Dialler, and voice driven menu facilities.

Voice communications to and from the Control Panel allow operations such as: Listen-in, 2 Way Audio, Input status enquiry (with Voice answer); Remote control of appliances (Turn ON/OFF); Arm/Disarm Partitions; Alarm Reset and Inhibit Calls.

Access to all the “over-the-phone” features requires a Telephone Access Code which can be disabled immediately after use.

Scheduler The Scheduler can be setup to Arm/Disarm Partitions automatically (on a daily or weekly basis), and to control **16** daily timer events.

Wireless Devices This Control Panel support up to 32 Wireless Detectors and up to 16 Wireless Keys, by means of the **VRX32-433**, **VRX32-433EN** or **VRX32-868** receivers (optional).

Programming This Control Panel can be programmed from the Keypad, or via the BOSS Software Application and a computer. The Software Application (runs under Windows) provides real-time supervisory facilities (via connection to a RS232 or USB Interface, or Teleservice), and will allow you to make the fullest use of all the system features.

Features

■ Common Features for all versions

Zones/outputs dynamic allocation Each zone and each output can be programmed as “Not used”. This will allow the installer to have the maximum number of zones even if an expander is not fully used. The panel will build a correspondence between the number of a zone and its physical location.

E.g. the zone nr. 7 can be located on expander nr. 1, terminal T1, and the zone nr. 8 can be located on expander nr. 2, terminal T4.

On board Inputs

- 4 zones
- 4 Programmable Terminals (Zones/Outputs)
- Zones supervision (NC / NO / EOL / DEOL)
- Fully-programmable input-zones
- 1 supervised (10 Kohm EOL) 24h Tamper Zone

On board outputs

- 1 Programmable Alarm Output 2 A relay (Bell output)
- 2 Programmable Open-Collector Outputs (100 mA each)
- 4 Programmable Terminals (Zones/100 mA Outputs)
- Fully Programmable Output options (polarity, Timing, Events, Timers)
- Supervised Bell circuit

Peripherals ABSOLUTA M-Touch, ABSOLUTA T-Line, LCD PREMIUM and CLASSIKA keypads, Expander M-IN/OUT module, PROXY and ECLIPSE2 Key readers, BXM12 Power supply stations.

Wireless

- 1 Wireless Receiver at 433 or 868 MHz
- Up to 16 wireless Keys
- Up to 32 wireless Detectors

Interfaces

- New Bentel BPI Plus bus (+12 V only)
- KEYBUS bus for wireless receiver
- PC-Link interface
- USB OnTheGo Device/Host

Options AS100 2-way audio station for remote listening (speaker and microphone).

Features	ABS-16	ABS-42	ABS-104
Zones on Board (Min/Max)	4/8		
Outputs on Board: Relay	1		
Outputs on Board: Open Collector (Min/Max)	2/6		
Max number of Wired Zones	16	42	104
Max number of Wireless Zones	32		
Max number of Zones	32	42	104
Max number of Outputs	6	20	50
Max Number of Input Expanders	32	32	32
Max Number of Output Expanders	16	16	16
Max Number of Keypads	8	8	16
Max Number of User PINs	31	63	127
Installer PINs	1		
Level 4 PINs	1		
Max Number of Key Readers	16	32	32
Max Number of Keys	64	128	250
Max Number of Wireless Keys	16		
Max Number of Power Supply Stations	4	4	4
Max Number of Wireless Receivers	1		
Max Number of Audio Stations	1		
GSM Module	1		
Partitions	8	8	16
Max Number of Events in Logger	2,000		
Timers	16		
Voice Messages	1 x 12 seconds + 205 x 6 seconds		
Telephone Numbers	32		

Table 1 Control panel feature comparison.

Communications

- Integrated PSTN interface
- Phone Line monitoring
- Double Call
- Line-sharing Management
- Up to 32 telephone numbers for Voice/SMS Dialler and Central Station
- Supports CONTACT ID and SIA Reporting Formats
- Programmable Test Call
- Remote servicing
- Periodic Transmission Test
- Integrated Voice Calls
- Up to 206 voice messages, total time 20,7 minutes
- Voice Guide by Telephone, with Remote DTMF device management
- Down-loadable Pre-Recorded Voice messages

Management

- 127+1 Programmable Codes (from 4 to 6 digits)
- Supports a total of 250 SAT Keys and/or Proxy-Cards
- Programmable Automatic Arming/Disarming features
- Partition Bypass for Patrol purposes with automatic or manual re-arming
- 5 Partitions Arming Mode:
 - Away arming on valid partitions
 - A, B, C, D modes: each mode can be programmed for any action on valid partitions (Only A and B modes are available for key-readers)
- Programming from a LCD or Touchscreen keypad
- Local programming from a PC via RS232/USB or by telephone line using standard modem (1200 bps)
- Local/remote downloading/programming
- Accepts commands from touch-tone phones (Arm, Disarm, Turn ON/OFF Outputs, Partition and Zone status check)
- Remote Talk/Listen-in (requires optional **AS100** 2-way audio station)
- Remote Telephone Access via DIALLER or ANSWER
- 2000 event memory with date and time details
- Priority management of events (processing and reporting): 1) Alarm/Hold-up, 2) Tamper, 3) Trouble and Bypass.
- 3 function keys for immediate Alarm calls from Keypad

GSM/GPRS Only with the optional ABS-GSM Module.

- Quad Band
- Support for the GSM/GPRS channel
- Main or backup dialler
- Transmission of voice messages by GSM
- Transmission of Contact ID and SIA by GSM
- Transmission of events in Contact ID and SIA format via GPRS to Sur-Gard SYSTEM II/III receivers.
- Reporting of events by SMS
- Library of 250 SMS messages: 1 heading message, 8 status messages, and 241 personal messages
- 32 events controlled by SMS
- 32 events controlled by caller ID (at no cost)
- Checks the control panel's status by SMS
- Checks the credit left on the prepaid SIM card
- Teleservice by Internet (GPRS)

Power supply Deep discharge battery protection.

Housing

- metal box for 17 Ah battery, with BAQ35 or BAQ60 power supply and 2 M-IN/OUT
- plastic box for 7 Ah battery, with BAQ15 or BAQ35 power supply

■ ABSOLUTA 16 features

- Up to 8 Keypads
- Up to 16 Key Readers
- Up to 32 Input Expanders (on the M-IN/OUT modules and/or PREMIUM and/or ABSOLUTA T-Line Keypads)
- Up to 16 Output Expanders (on the M-IN/OUT modules)
- Up to 16 fully-programmable wired zones
- Up to 6 Outputs
- Up to 32 wireless zones (with external receiver)
- Up to 32 total zones (wired + wireless)
- Up to 8 independent Partitions

■ ABSOLUTA 42 features

- Up to 8 Keypads
- Up to 32 Key Readers
- Up to 32 Input Expanders (on the M-IN/OUT modules and/or PREMIUM and/or ABSOLUTA T-Line Keypads)
- Up to 16 Output Expanders (on the M-IN/OUT modules)
- Up to 42 fully-programmable wired zones (with external Input Expanders)
- Up to 20 Outputs (with external Output Expanders)
- Up to 32 wireless zones (with external receiver)
- Up to 42 combined zones (wired + wireless)
- Up to 8 independent Partitions

■ ABSOLUTA 104 features

- Up to 16 Keypads
- Up to 32 Key Readers
- Up to 32 Input Expanders (on the M-IN/OUT modules and/or PREMIUM and/or ABSOLUTA T-Line Keypads)
- Up to 16 Output Expanders (on the M-IN/OUT modules)
- Up to 104 fully-programmable wired zones (with external Input Expanders)
- Up to 50 Outputs (with external Output Expanders)
- Up to 4 power Supply Stations
- Up to 32 wireless zones (with external receiver)
- Up to 104 combined zones (wired + wireless)
- Up to 16 independent Partitions

Versions	Main Boards	Boxes	Power Supplies
ABS16P15*	ABS16	ABS-P	BAQ15T12
ABS16P35*			BAQ35T12
ABS42P15*	ABS42		BAQ15T12
ABS42P35*			BAQ35T12
ABS16M35	ABS16	ABS-M	BAQ35T12
ABS42M35*	ABS42		BAQ35T12
ABS42M60*			BAQ60T12
ABS104M35*	ABS104		BAQ35T12
ABS104M60*			BAQ60T12

Table 2 Control Panel versions: * 

Control Panel versions

You can create the Control Panels listed below, by assembling the available components, as shown in the Table 2.

ABS16P15 Up to 8 Zone Control Panel, expandable up to 16 zones, in Plastic Box with 1.5 A Power Supply.

ABS16P35 Up to 8 Zone Control Panel, expandable up to 32 zones, in Plastic Box with 3 A Power Supply.

ABS42P15 Up to 8 Zone Control Panel, expandable up to 42 zones, in Plastic Box with 1.5 A Power Supply.

ABS42P35 Up to 8 Zone Control Panel, expandable up to 42 zones, in Plastic Box with 3 A Power Supply.

ABS16M35 Up to 8 Zone Control Panel, expandable up to 16 zones, in Metal Box with 3 A Power Supply

ABS42M35 Up to 8 Zone Control Panel, expandable up to 42 zones, in Metal Box with 3 A Power Supply.

ABS42M60 Up to 8 Zone Control Panel, expandable up to 42 zones, in Metal Box with 5 A Power Supply.

ABS104M35 Up to 8 Zone Control Panel, expandable up to 104 zones, in Metal Box with 3 A Power Supply.

ABS104M60 Up to 8 Zone Control Panel, expandable up to 104 zones, in Metal Box with 5 A Power Supply.

■ The boxes

The following Boxes are available for the ABSOLUTA Control Panels.

ABS-P Is a plastic box that supports the **ABS16** and **ABS42** Main Boards, and the **1.5 A** and **3 A** Power Supplies. In addition it can house a backup battery up to **7 Ah** and an **M-IN/OUT** Input/Output Expander Module. The Plastic Box package includes the following parts:

- the Backplate;
- the Cover;
- 1 x 21 cm Earth wire (Yellow-Green) without eyelet;
- 1 self tapping screw — 2.9 x 9.5 to secure the BAQ35T12 Switching Power Supply;
- 2 self tapping screws — 3 x 8 to secure the BAQ15T12 Switching Power Supply;
- 2 self tapping screws — 3.9 x 9.5 to secure the Cover.
- 1 self tapping screw 3 x 8 to secure the possible M-IN/OUT;
- 2 self tapping screw 3 x 8 to secure the main board;
- 1 Data label
- 2 PVC “Protected Environment” Label

ABS-M Is a metal box that supports the **ABS16**, **ABS42** and **ABS104** Mother Boards, and the **3 A** and **5 A** Power Supplies. In addition it can house a backup battery up to **17 Ah** and up to two **M-IN/OUT** Input/Output Expander Modules. The Metal Box package includes the following parts:

- the Backplate;
- the Cover;

- 5 x 13 mm reverse locking supports for the ABSOLUTA Main Board;
- 8 x 10 reverse locking supports for two M-IN/OUT Expander PCBs;
- 1 x 12 cm Earth wire (Yellow-Green) with eyelet;
- 1 plastic wall-tamper bracket;
- 2 (1 x 3) mm cogged metal washers;
- 2 “Protected Environment” label.
- 1 self tapping screw 3 x 6 to secure the Earth wire (Yellow-Green) with eyelet;
- 1 3 x 8 screw to secure the BAQ35T12 switching power supply;
- 1 Data label.

■ The Main Boards

The following Main Boards are available for the ABSOLUTA Control Panels.

ABS16 Up to 8 zone Main Board, expandable up to 16 zones.

ABS42 Up to 8 zone Main Board, expandable up to 42 zones.

ABS104 Up to 8 zone Main Board, expandable up to 104 zones.

The Main Board package includes the following parts:

- the Main Board;
- the Product Label;
- the Battery cable;
- the Multilanguage Quick User Guide.

■ The Power Supplies

The following Power Supplies (Type A - EN50131-6) are available for the ABSOLUTA Control Panels.

BAQ15T12 1.5 A @ 13.8 Vdc Switching Power Supply.

BAQ35T12 3 A @ 13.8 Vdc Switching Power Supply.

BAQ60T12 5 A @ 13.8 Vdc Switching Power Supply.

 *Read the Power Supply's instructions for more information.*

■ The Accessories

The following accessories are available to improve the performances of the ABSOLUTA Control Panels.

MAXIASNC Switch for open/removal detection.

KST Thermal Probe.

■ Plug-In Modules

The following plug-in modules can be installed inside the ABSOLUTA box to expand the capability of the Control Panel.

M-IN/OUT Input/Output Expander.

ABS-GSM GSM Module.

Compatible items

Following a brief description of the items supported by the ABSOLUTA, shown on the Table 3: refer to the items instructions for further information.

ABS-GSM This is a GSM module that can be used by the control panel as a backup dialler if the internal PSTN dialler malfunctions or is tampered or can replace it completely in areas accessed by mobile phone services where a PSTN line is not available.

In that sense, the GSM Module is completely transparent to the control panel for the following functions:

- transmission of voice messages over a GSM channel;
- transmission of events with Contact ID and SIA protocol over a GSM channel;
- managing the control panel by telephone.

The GSM Module also allows you to:

- send SMS messages to a series of telephone numbers in order to report events (alarms, tampers, troubles, etc.);
- activate/deactivate the actions of the control panel (outputs, voice messages, etc.) by sending SMS messages to the number of the GSM Module;
- activate actions just by recognizing the number that is calling the GSM Module (at no cost);
- check the control panel's status by phone by sending and receiving SMS messages;
- perform Teleservice (remote management and programming of the control panel) over the Internet on a GPRS channel.

M-IN/OUT The **M-IN/OUT** is an Input/Output Expander which allows the number of zones and outputs of the Control Panel to be increased. It can be programmed to function as: 6-zone Input Expander; Output Expander with 6 Outputs; Input/Output Expander with 4 zones and 2 Outputs; Input/Output Expander with 2 zones and 4 Outputs. In this manual the term **Input Expander** will be used to refer to the **M-IN/OUT** programmed to function as an Input Expander or Input/Output Expander; the term **Output Expander** will be used to refer to the **M-IN/OUT** programmed to function as an Output Expander or Input/Output Expander.

 An **M-IN/OUT** programmed as an Input/Output Expander contributes both to the number of Input Expanders and to the number of Output Expanders connected to the Control Panel.

 In order to comply with EN50131-1 and EN50131-3 standards, the tamper and wall-tamper contacts of the M-IN/OUT installed outside of the panel container, must be enabled: the M-IN/OUT's **TAMP DIS** jumper must be removed.

ABS-GSM	GSM Module
BGSM-100CA	GSM Antenna for metal box (ABS-M)
ABS-AK	GSM Antenna for plastic box (ABS-P)
ANT-EU	External GSM Antenna
M-IN/OUT	6 Input/Output Expander
ABSOLUTA M-Touch	Touchscreen Keypad
ABSOLUTA T-Black	LCD keypad with Input/Output Expander and Proximity Reader on-board, black
ABSOLUTA T-White	LCD keypad with Input/Output Expander and Proximity Reader on-board, white
PREMIUM LCD	LCD Keypad with Input/Output Expander and Proximity Reader on board
CLASSIKA LCD	LCD Keypad
ECL2-UKR (ECLIPSE2)	Recessed Universal Reader Module for Proximity Key
ECL2-C (ECLIPSE2)	Cover for ECL2-UKR Universal Reader Module
PROXI	Indoor/Outdoor Proximity Reader (IP34), for Proximity Key
SAT	Proximity Key
SAT2	Proximity Key
PROXI-CARD	Proximity Card
MINIPROXI	Proximity Tag
PROXI-TAG/B	Black Proximity Tag
PROXI-TAG/G	Gray Proximity Tag
PROXI-TAG/W	White Proximity Tag
AS100	Microphone + Loudspeaker Station
BRM04/12	4-Relay module for open-collector outputs
BXM12-B/30	3 A BPI Power Supply Station
BXM12-B/50	5 A BPI Power Supply Station
VRX32-868	868 MHz KEYBUS Receiver
VRX32-433	433 MHz KEYBUS Receiver
VRX32-433EN	433 MHz KEYBUS Receiver
VRP-433	433 MHz Repeater
MAXIASNC	Big NC Tamper Switch
KST	Thermal Probe
BLUM03	USB Modem
USB5M	5 m USB Cable
BOSS	Console Software

Table 3 Compatible items.

Access Control Devices The ABSOLUTA supports ECLIPSE2 and PROXI Digital Key Readers, and M-touch, T-Black, T-White, PREMIUM LCD and CLASSIKA LCD Keypads.

The operating principles of the ECLIPSE2 and PROXI Readers are the same, except:

- **ECLIPSE2** Readers accept SAT Keys and PROXI-CARD and are for indoor use (unless mounted inside weatherproof boxes);

 *The ECLIPSE2 Key Reader is classified by the EN50131-3 standard as Auxiliary Control Equipment (ACE), Type A.*

- **PROXI** Readers have weather strips, and can be installed indoors or outdoors (IP34 Protection Class) and accept SAT Keys and PROXI-cards.
- **ECLIPSE2** and **PROXI** Systems operate without contacts, therefore, are highly resistant to oxidization and wear.

 *The PROXI Proximity Reader is classified by the EN50131-3 standard as Auxiliary Control Equipment (ACE), Type A.*

- The operating principles of the **T-Black**, **T-White**, **PREMIUM** and **CLASSIKA** Keypads are the same, with a large display (2 lines of 16 characters); only the **T-Black**, **T-White** and **PREMIUM** Keypads have on-board proximity reader.

 *The T-Black, T-White and PREMIUM LCD keypads and the CLASSIKA LCD keypad are classified by the EN50131-3 standard as Auxiliary Control Equipments (ACE), respectively Type B and Type A.*

- The M-Touch keypad has a large display allowing the graphical display of information about the system in colour. In addition, the display is touch sensitive so interaction with this keypad is easy and intuitive.

Wireless Receivers This Control Panel supports one **VRX32-433**, **VRX32-433EN** or **VRX32-868** receiver connected to the KEY BUS. This receiver support up to 32 Wireless Detectors and up to 16 Wireless Keys.

The **VRX32-433** and **VRX32-433EN** receivers support the following Detectors:

- AMD20, AMD20NP - Wireless Pet-immune Infrared Detector , PIR Detector
- AMC30 - Wireless Magnetic Contact
- ASD20 - Wireless Optical Smoke Detector

The **VRX32-868** receiver support the following Detectors:

- KMD20/ KMD20NP - Wireless Pet-immune Infrared Detector , PIR Detector
- KMC10/KMC20/KMC30 - Wireless Magnetic Contact
- KSD20 - Wireless Optical Smoke Detector

The Control Panel can detect Alarm, Tamper, Low Battery and Lost Wireless Detectors.

 *The following devices are NOT certified IMQ-SECURITY SYSTEMS and then NOT comply to EN50131-1 and EN50131-3: **VRX32-433** and **VRX32-868** receivers; **KMD20**, **KMD20NP**, **KMC10**, **KMC20**, **KMC30**, **ASD20** and **KSD20** wireless detectors.*

When a Wireless Detector (assigned to a Zone) detects Alarm conditions, the Control Panel will generate the respective **Alarm on zone** event, and other events which depend on the programmed "Type" (refer to "Type" under "Zones").

When a Wireless Detector (assigned to a Zone) detects Tamper conditions, the Control Panel will generate the respective **Tamper on zone** event, and other events which depend on the programmed "Type" (refer to "Type" under "Zones").

When the battery of a Wireless Detector (assigned to a Zone) is Low, the Control Panel will generate a **Warning low battery on wireless detector** event. This event will not identify the Wireless detector concerned. However, the respective information will be recorded in the log as follows:

- TYPE - Low Battery
- ID. EVENT - Label of the Wireless Zone no.

When a Wireless Detector fails to transmit a supervisory signal within a certain time frame, the Control Panel will generate a **Lost wireless zone** event.

Power station The Power station has been especially designed for Security system applications. The tamper protected box (protected against opening and forced removal) can house a backup battery for power supply during black-out. This Control Panel supports **BXM12-B/30** 3 A Power Station and **BXM12-B/50** 5 A Power station.

 *The **BXM12-B/30** and **BXM12-B/50** power stations are NOT certified IMQ-SECURITY SYSTEMS and then NOT comply to the EN50131-1, EN50131 and EN50131-3-6 standards.*

BOSS The BOSS software (runs under Windows) provides full Programming, Customer Database and real-time Supervisory functions, and will allow you to make the fullest use of all the system features.

BLUM03 It is a standard modem that will allow you to Upload/Download options and carry out remote management of the control panel by phone (Teleservice).

Access Levels for panel management

Level 1 Access by any person: at this level you can activate only the Super-keys (the keys 1, 2 and 3 pressed for at least 3 seconds). Eg. 1: Emergency, 2: Fire, 3: Alarm.

Level 2 Access by the Master, Limited and Normal user, after entering a PIN (see “Quick guide for the LCD Keypad menu” in the “APPENDIX” section).

Level 3 Access by the Installer, after entering a PIN (see “KEYPAD OPERATIONS” section and “Quick guide for the LCD Keypad menu” in the “APPENDIX” section).

Level 4 Access by the Installer or the manufacturer’s qualified personnel, after entering a PIN (see “KEYPAD OPERATIONS” section and “Quick guide for the LCD Keypad menu” in the “APPENDIX” section).

Updates

The paragraphs below list the main updates for each version of the Control Panel, together with the paragraphs in this manual and the USER MANUAL where information on these can be found.

■ 2.10

ABSOLUTA App iPhone and Android App for managing the Control Panel from a smartphone:

- PROGRAMMING FROM THE PC > Events and Actions > Remote Controlled Events.

For more information, visit the BENTEL SECURITY site (www.bentelsecurity.com), the App Store (<https://itunes.apple.com>) or the Google Play Store (<https://play.google.com/store>).

In order to manage the Control Panel using the ABSOLUTA APP, the user must know the IMEI of the GSM Module installed on their Control Panel:

- USER MANUAL > KEYPAD OPERATIONS > View > GSM Module Status (3.3);
- USER MANUAL > SMS OPERATIONS > GSM Module IMEI Request.

Arming/Disarming via SMS Option to Arm/Disarm the Partitions via SMS:

- USER MANUAL > SMS OPERATIONS > Arm/Disarm the Partitions.

■ 3:00

Auto-reset Automatically reset of alarms stored during the arming period:

- PROGRAMMING FROM THE PC > System Options > Reset alarm/tamper memory on arming (Master code - keys);
- USER MANUAL.

Storing SMS The GSM module is capable of storing up to 32 SMS:

- KEYPAD OPERATIONS > 3.3) View GSM Module Status;
- USER MANUAL.

Sur-Gard SYSTEM II/III Receiver Support Transmission of events to the Sur-Gard SYSTEM II/III via GPRS, with Contact ID and SIA reporting formats:

- PROGRAMMING FROM THE PC > Events and Actions > Telemonitoring;
- PROGRAMMING FROM THE PC > GSM > Cellular.

ABSOLUTA M-Touch Support for the new ABSOLUTA M-Touch touchscreen keypad:

- USER MANUAL > TOUCH KEYPAD OPERATIONS.

 *The ABSOLUTA 3.00 does NOT support LED (PREMIUM and CLASSIKA) keypads.*

Technical Specifications

Table 4 shows the technical Specifications of the ABSOLUTA series.

The below table shows the current draw (I (mA) column) and size of the accessory components.

Components	I (mA)	Size (WxHxD mm)
ABSOLUTA Main Board	150	175x99x17
ABS-GSM Module	250	99x65,5x12
ABSOLUTA M-Touch keypad	300	195x127.9x20.3
ABSOLUTA T-Line Keypad with proximity reader enabled	60	134x114x28,5
	50	

PREMIUM Keypad with proximity reader enabled	60	134x114x28.5
	50	
CLASSIKA Keypad	50	144.5x116x27.5
ECLIPSE2 Key Reader	30	—
PROXI Key Reader	30	78x108x22
M-IN/OUT Programmable Input/Output Expander	20	108x101x34
	120	
BRM04/12 4 Relay Module	120	
BXM12-B/30 Power Station	10	240x348x97
BXM12-B/50 Power Station	10	240x348x97

Versions	ABS16P15 ABS42P15	ABS16P35 ABS42P35	ABS16M35 ABS42M35 ABS104M35	ABS42M60 ABS104M60
Voltage	230 V \sim -15/+10% 50/60 Hz		230 V \sim -15/+10% 50/60 Hz	
Max. Current Draw	0.42 A		0.5 A	0.9 A
Power Supply Battery-Charger (Type A - EN50131-6)	13.8 V --- \pm 2% 1.5 A	13.8 V --- \pm 1% 3 A		13.8 V --- \pm 1% 5 A
Insulation Class	I			
Maximum ripple voltage on the outputs	310 mV (2.25%)			
Battery (Brand and Type)	Lead Acid 12 V / 7 Ah YUASA NP 7-12 FR or similar Case Flame Class UL94-V2 or higher		Lead Acid 12 V / 17 Ah YUASA NP 17-12 FR or similar Case Flame Class UL94-V2 or higher	
Max. Current available for peripherals and loads (Aux Output)	430 mA (7 Ah battery)		1,250 mA (17 Ah battery)	
Max. Battery Charge Current	0.92 A (7 Ah battery)	2.42 A (7 Ah battery)	1.6 A (17 Ah battery)	3.6 A (17 Ah battery)
Maximum Battery Recharge Time to 80%	24 h			
Minimum Duration of Alternative Power Supply	12 h			
Low Battery Fault Generated	11.4 V			
Digital Key Combinations	4,294,967,296			
Alarm Transmission System	ATS2			
Delay for alarm messages generation and transmission	6 s			
Delay for fault detection and visualization	6 s			
IP Protection Grade	IP20			
Security Grading	2			
Environmental Class	II			
Operating Temperature	-10 to +40 °C			
Operating Humidity (not condensed)	0 to 93% RH			
Dimensions (WxHxD)	319x352x92 mm (without antenna)		310x403x103 mm (without antenna)	
Weight	2.09 Kg (without battery)		4.89 Kg (without battery)	
Complies with	EN60950-1/A1:2010; EN50130-4/A2/Corr.:2003; EN50131; EN50136			

Table 4 Technical Specifications.



IDENTIFICATION OF PARTS

Please read this section carefully to get an overall view of the main components of the Control Panel.

The numbers in boldface (used in this text) refer to the descriptions in the tables and figures in this section.

The components are generally numbered in clockwise order. The outlined numbers refer to the common hardware components of the BPI devices and are described once only — when first encountered.

Figures 2 and 3 show the maximum configuration of the respective Control Panels, therefore, some of the components may not be present on your Control Panel.

N.	DESCRIPTION
1	Main board fixing holes
2	Jumper to disable the activation of the Outputs and Telephone Actions (Voice Calls, Voice Messages on AS100, Digital Calls and SMS):  = Actions Enabled (factory settings);  = Actions Disabled.
3	Opening tamper switch connector
4	Wall tamper switch connector

N.	DESCRIPTION
5	Future use
6	Future use
7	Future use
8	Future use
9	Microprocessor
10	RS232 Serial Port
11	Terminals for telephone line connection
12	Switching power Supply connector
13	Connector for backup Battery
14	Input terminals for detector connection
15	Programmable terminals as inputs or outputs
16	KEY BUS terminals for Wireless Receiver connection
17	BPI BUS terminals for BPI peripheral connection
18	Terminals for Audio Station connection
19	Terminals for Tamper Line connection
20	Terminals for output device connection (Sirens, etc.)
21	USB serial port for downloading/uploading by PC
22	USB Serial Port for downloading/uploading by USB pen

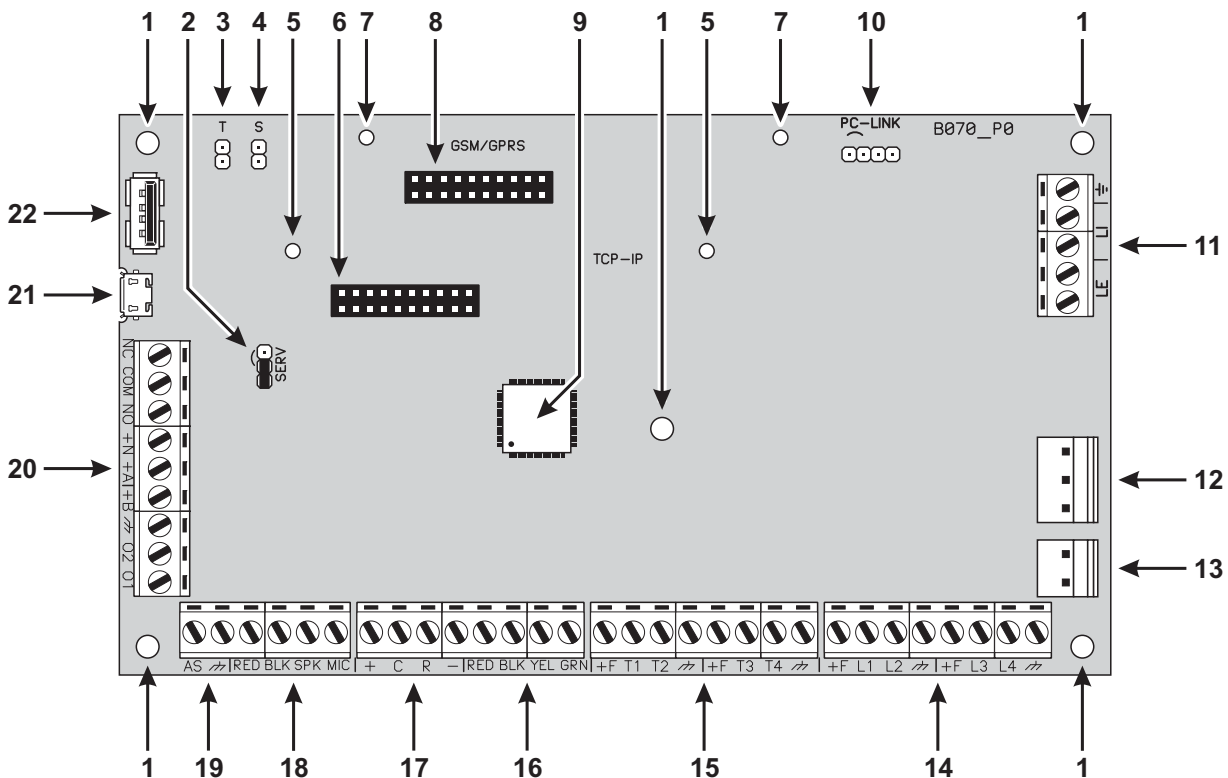

Figure 1 ABSOLUTA Main Board parts.

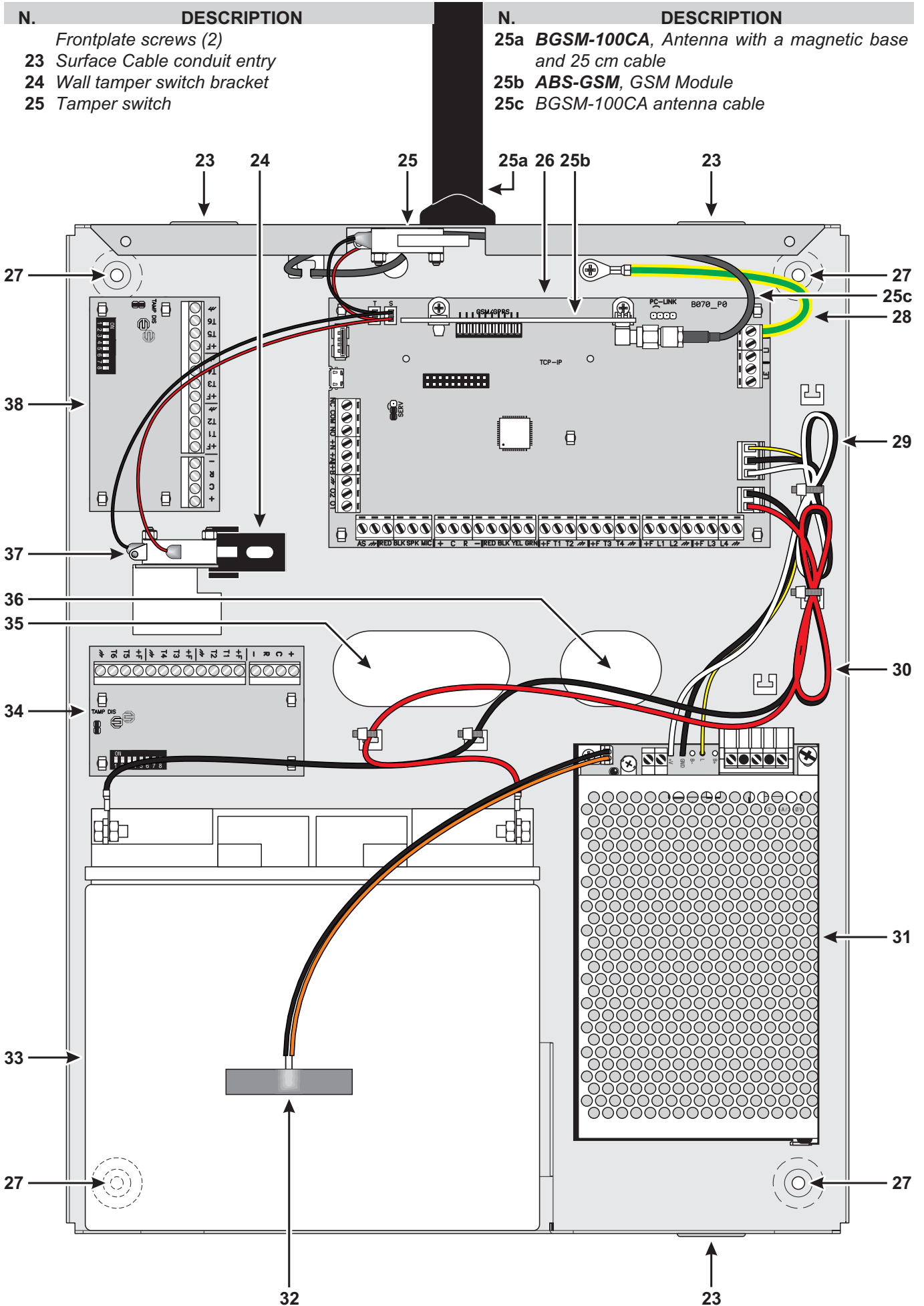

Figure 2 Parts of the ABSOLUTA in the Metal Box.

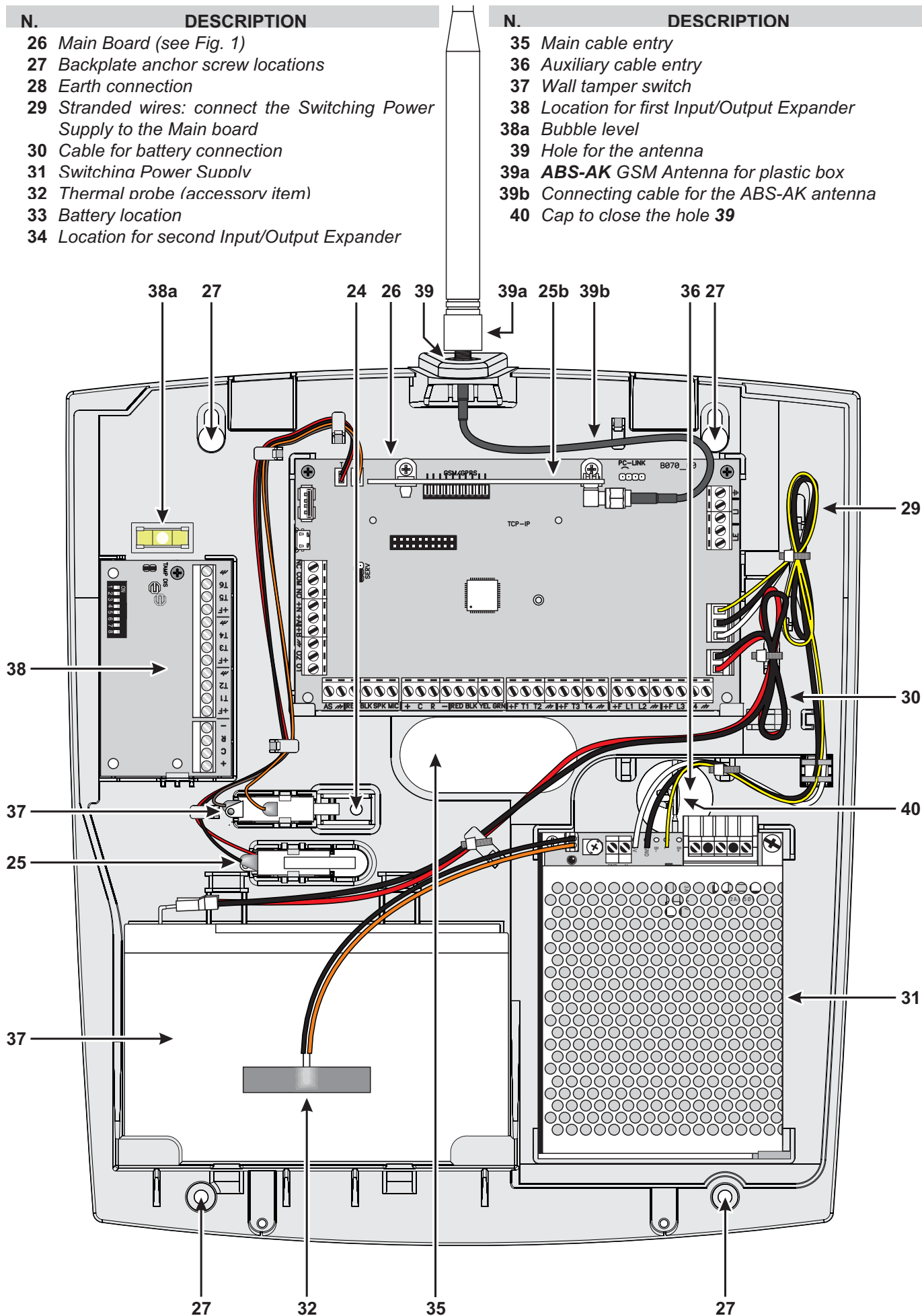

Figure 3 Parts of the ABSOLUTA in the Plastic Box.

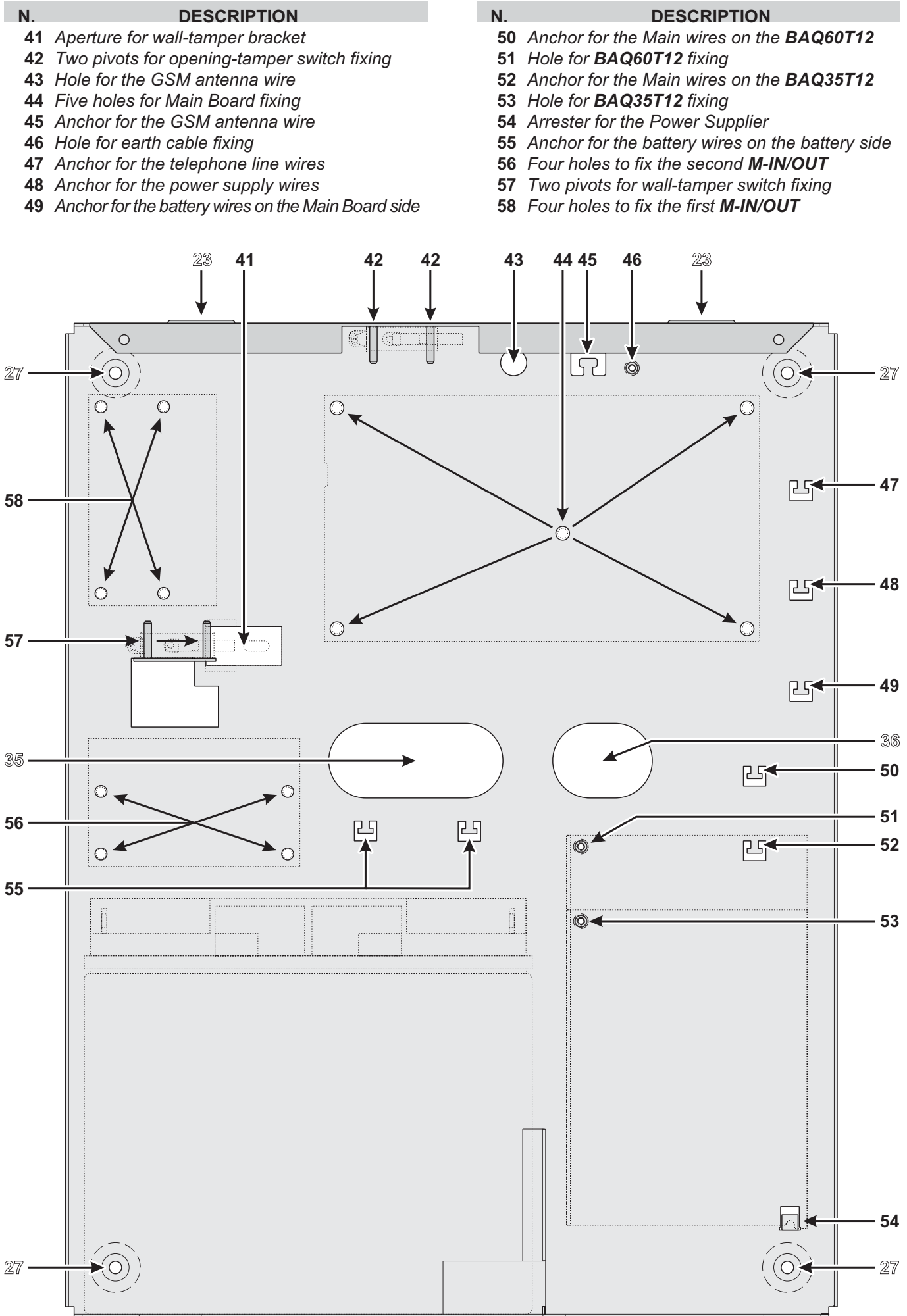

Figure 4 Mounting the Metal Box.

MOUNTING THE COMPONENTS

Mounting the Metal Box

Please read the following instructions, to get an overall view of the steps involved in the control panel mounting with the **ABS-M** Metal Box: refer to Figure 4 and Figure 2 on page 14.

Installing ABSOLUTA Main Board

1. Insert the five reverse locking supports into the holes **44** on the backplate.
2. Place the Main Board on the supports, then press it down until blocks in its position.
3. Secure the Earth wire (Yellow-Green) eyelet to the hole **46** on the backplate, by means the screw M3x8 and washer.
4. Connect the other end of the Earth wire (Yellow-Green) **28** to terminal ⏏ on the ABSOLUTA Main Board.

 **The Main Board must be earthed in order to protect it from electrical surges from the Telephone Line, and comply with Safety Regulations.**

Installing the Switching Power Supply You can install the Switching Power Supply BAQ35T12 or BAQ60T12 into the Metal Box, as shown in Figure 2 on page 14 (part nr. **31**).

5. Cut the battery cables on the power supply.

 *The backup battery must be connected to the connector **13** on the Main Board. It can NOT be connected directly to power supply.*

6. Slide the Power Supply tab under the hook **54** on the backplate.
7. Secure the BAQ35T12/BAQ60T12 to the hole **53/51** on the back plate, by means the washer and screw (M3x8).
8. Insert the Power Supply plug into the connector **12** on the Main Board.
9. Secure the exceeding wires to the anchor **48** on the backplate.

Installing the Tamper Switch You can install the **MAXIASNC** switch (accessory item required to comply with the EN50131-1 and EN50131-3 standards) to detect the box opening, as shown in Figure 2 on page 14 (part nr. **25**).

10. Secure the **MAXIASNC** switch to its location using the two hexagonal nuts.
11. Connect the wire to the connector **3(T)** on the Main Board.

Installing the Wall-Tamper Switch You can install the **MAXIASNC** switch (accessory item required to comply with the EN50131-1 and EN50131-3 standards) to detect the box removal, as shown in Figure 2 on page 14 (part nr. **37**).

12. Place the Wall-Tamper Bracket **24** into the opening **41** on the backplate.
13. Secure the **MAXIASNC** switch to its location using the two hexagonal nuts.
14. Connect the wire to the connector **4(S)** on the Main Board.

Installing the Input/Output Expander Module You can install up to two Input/Output Expander Modules **M-IN/OUT** into the Metal Box, as shown in Figure 2 on page 14 (parts nr. **34** and **38**).

15. Insert four reverse locking supports into the holes **58** and/or into the holes **56** on the backplate, depending on if you are installing one and/or two Modules.
16. Place the Module PCB on the supports, then press it down until blocks in its position.
17. Disable the tamper and wall-tamper contacts by inserting (closing) the jumper on the Input/Output Expander Module (**TAMP DIS**).

Marking Label Once you have assembled the components, specify the type of Control Panel that you have constructed.

18. Using an indelible pen, tick the relevant box on the Marking Label according to the following table.

ABS-M Main Boards	Power Supplies	
	BAQ35T12	BAQ60T12
ABS16	ABS16M35	N/A
ABS42	ABS42M35	ABS42M60
ABS104	ABS104M35	ABS104M60

19. Attach the Marking Label on the outside right side of the metal box.

Mounting the Plastic Box

Please read the following instructions, to get an overall view of the steps involved in the control panel mounting with the **ABS-P** Plastic Box: refer to Figure 5 and Figure 3 on page 15.

 To comply with the EN50131-1 and EN50131-3 standards, detach the cap **40** from the bottom, and insert it into the hole **39**.

Installing ABSOLUTA Main Board

- Slide the Main Board under the 2 tabs **67**.
- Secure the Main Board to the holes **60** on the backplate using the two self tapping screws .

Installing BAQ15T12 Switching Power Supply

Read the following steps to install the BAQ15T12 Switching Power Supply, otherwise skip to “Installing BAQ35T12 Switching Power Supply”.

- Cut the battery cables on the power supply.

 The backup battery must be connected to the connector **13** on the Main Board. It can NOT be connected directly to power supply.

- Using the 2 self tapping screws (3 x 8), secure the BAQ15T12 to the holes **71** on the backplate..
- Connect one end of the Earth wire (Yellow-Green) **28** to the Earth terminal \perp on the ABSOLUTA Main Board, and the other to terminal \oplus on the BAQ15T12 Switching Power Supply.

 **The Main Board must be earthed in order to protect it from electrical surges from the Telephone Line, and to comply with Safety Regulations.**

- Plug the Switching Power Supply into the connector **12** on the ABSOLUTA Main Board.

Installing BAQ35T12 Switching Power Supply

Read the following steps to install the BAQ35T12 Switching Power Supply or skip to “Installing the Tamper Switch”.

- Cut the battery cables on the power supply.

 The backup battery must be connected to the connector **13** on the Main Board. It can NOT be connected directly to power supply.

- Locate the BAQ35T12 onto its supports on the backplate. Ensure that the Switching Power Supply is secured firmly in place by the arrester **72**.
- Using the self tapping screw (3 x 8), secure the BAQ35T12 to the hole **75** on the backplate.

- Connect one end of the Earth wire (Yellow-Green) to terminal \perp on the ABSOLUTA Main Board, and the other to terminal \oplus on the BAQ35T12 Switching Power Supply.

 **The Mother Main must be earthed in order to protect it from electrical surges from the Telephone Line, and comply with Safety Regulations.**

- Insert the Switching Power Supply plug into the connector **12** on the ABSOLUTA Main Board.

Installing the Tamper Switch You can install the **MAXIASNC** switch (accessory item required to comply with the EN50131-1 and EN50131-3 standards) to detect the box opening, as shown in Figure 3 on page 15 (part nr. **25**).

- Insert the **MAXIASNC** switch into its location.
- Connect the wire to the connector **3 (T)** on the Main Board.

Installing the Wall-Tamper Switch You can install the **MAXIASNC** switch (accessory item required to comply with the EN50131-1 and EN50131-3 standards) to detect the box removal, as shown in Figure 3 on page 15 (part nr. **37**).

- Insert the **MAXIASNC** switch into its location.
- Connect the wire to connector **4 (S)** on the Main Board.

Installing the Input/Output Expander Module You can install one Input/Output Expander Module **M-IN/OUT** into the Plastic Box, as shown in Figure 3 on page 15 (part nr. **38**).

- Slide the Module PCB under the tab **78**.
- Secure the PCB to the hole **79** on the backplate, using the self tapping screw.
- Disable the tamper and wall-tamper contacts by inserting (closing) the jumper on the Input/Output Expander Module (**TAMP DIS**).

Marking Label Once you have assembled the components, specify the type of Control Panel that you have constructed.

- Using an indelible pen, tick the relevant box on the Marking Label according to the following table.

ABS-P	Power Supplies	
Main Boards	BAQ15T12	BAQ35T12
ABS16	ABS16P15	ABS16P35
ABS42	ABS42P15	ABS42P35

- Attach the Marking Label in the backplate (near the battery).

N.	DESCRIPTION
59	Two hooks to hang the Cover
60	Two holes for Main Board fixing
61	Four anchors to fix the tamper switch wires
62	Future use
63	Anchor for earth wire fixing
64	Anchor for the telephone line wires
65	Anchor for the power supply wires
66	Anchor for the battery wires on the Main Board side
67	Two tabs to retain the Main Board
68	Future use
69	Future use

N.	DESCRIPTION
70	Anchor for the Main wires on the BAQ35T12
71	Two holes for BAQ15T12 fixing
72	Arrester for the BAQ35T12
73	Two holes to secure the Cover
74	Anchor for the Main wires on the BAQ15T12
75	Hole for BAQ35T12 fixing
76	Anchor for the battery wires on the battery side
77	Two guides to anchor the battery
78	Tab to retain the M-IN/OUT
79	Hole for M-IN/OUT fixing

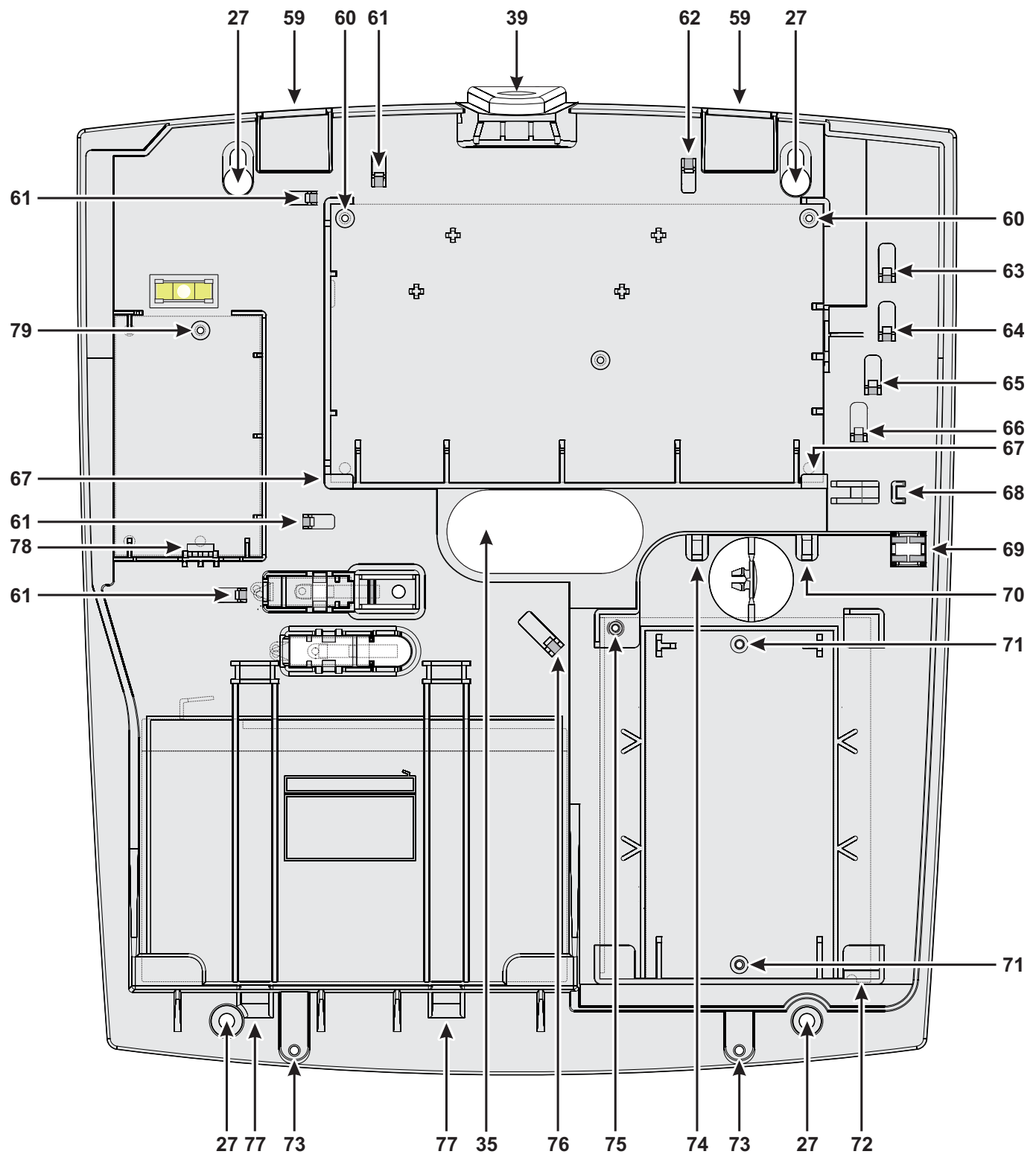

Figure 5 Mounting the Plastic Box.

Installing the GSM Module

⚠ Before installing the GSM Module, make sure that the control panel is not connected to the power supply.

⚠ Before inserting or removing the SIM card, make sure that the GSM Module is not connected to the power supply.

👉 Disable the PIN and call forwarding on the SIM card before inserting it in the GSM Module.

The **ABS-GSM** Module can be installed in the ABS-M metal box and the ABS-P plastic box as shown in Figure 2 on page 14 and in Figure 3 on page 15 (part n. 25b) respectively and described below (see Figure 6).

1. Insert the SIM card in SIM holder **102** of the Module.
2. Insert the GSM Module on connector **8** (**GSM/GPRS**), while being careful to make the holes on corner guards **101** coincide with the holes **7** on the Motherboard.

⚠ Inserting the GSM Module incorrectly may lead to serious damage.

3. Attach the GSM Module to the holes **7** using the screws provided.

Metal Box Installation in the ABS-M metal box requires antenna **BGSM-100CA** (b).

4. Place antenna **BGSM-100CA** on the top of the metal box as far away from the wall as possible.
5. Thread the antenna's wire through hole **43** on the bottom of the control panel and then connect it to connector **93** of the GSM Module.
6. Fix the antenna wire to anchor **45**.

Plastic Box Installation inside plastic box ABS-P requires the **ABS-AK** antenna (c).

7. Remove bolt **95** and washer **96** from connector **97** of wire **98** provided with the ABS-AK antenna.
8. Insert connector **97** in hole **39** of the ABS-P box.
9. Insert washer **96** and screw in bolt **95** until connector **97** is blocked.
10. Screw antenna **94** onto connector **97**.
11. Screw connector **99** onto the Module's connector **93**.

Check that the GSM signal is strong enough at the location chosen for the control panel's installation (see **Status** page); if it is NOT strong enough, try to move the antenna on the metal box or the control panel or try with the **ANT-EU** external antenna.

Program the options for the GSM Module: **GSM** and **SMS Message** option groups.

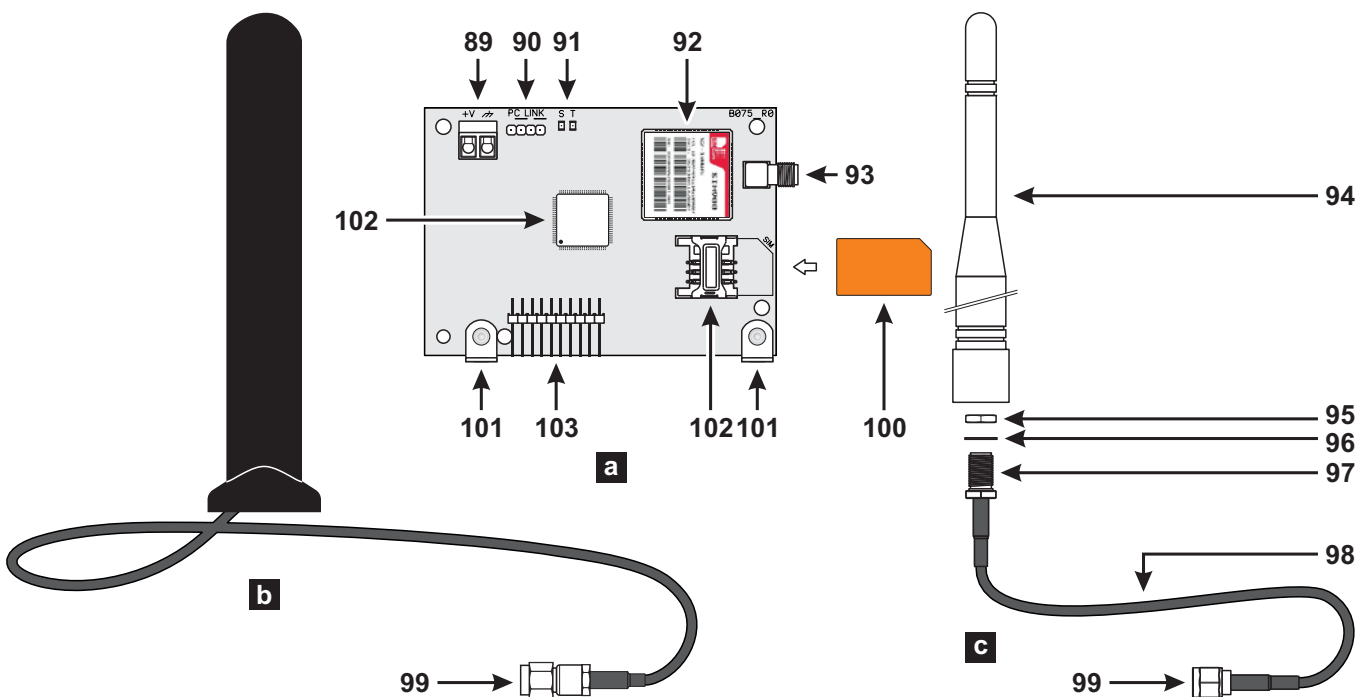

Figure 6 Parts of the **ABS-GSM** Module (a), of the **BGSM-100CA** antenna for metal box (b), and of the **ABS-AK** antenna for plastic box (c).

Mounting the Control Panel

Please read this section carefully to get an overall view of the steps involved in installing the ABSOLUTA Control Panel.

The ABSOLUTA Control Panel should be located in a safe, dry place that is far from sources of interference.

Once you have selected a suitable place, create a layout of all the system peripherals (Keypads, Readers, Detectors, etc.) and ensure that you will be able to connect the Main power, peripherals, and if necessary, the telephone line to the ABSOLUTA without difficulty.

Allow at least 5 cm of free space around the Main Unit for air flow.

 **The Main Unit must be at least 2 metres from relay systems.**

Work carefully through the following steps (see figures on pages 14 and 15).

1. Remove the screws and frontplate.
2. Install the accessory and plug-in modules following the instruction in the “MOUNTING THE COMPONENTS” section.
3. Drill the holes for the backplate and wall-tamper bracket anchor screws (**27** and **24** respectively).
4. Pull the connection wires through the wire entry **35** and **36** then attach the backplate and wall-tamper bracket to the wall.

 *DO NOT over tighten the screws as this may damage the wall-tamper bracket.*

5. Complete the connections — DO NOT connect the MAINS until all other wiring has been completed.
6. Connect the Mains Power (refer to “Connecting the Mains Power”).
7. Program the system (refer to the “PROGRAMMING FROM THE PC” and the “KEYPAD OPERATIONS” sections for instructions).

Mounting the BPI Peripherals

Read the instructions provided to mount the BPI peripherals.

Keypads Keypads should be located in places where full control of the system is required.

Readers Readers can be located in places where limited control of the system is required (Arming, A and B Mode Arming, Disarming operations).

Input/Output Expander Fix the M-IN/OUT Input/Output Expander as close as possible to the devices to which it is to be connected.

Power Stations Locate the Power Supply Station as near as possible to the devices it must supply, this will reduce the voltage drop on the connections to a minimum.

Terminals

This paragraph describes the Control Panel terminals. The layout of Terminal Description table is as follows:

- the **Ter.** column shows the terminal identifier;
- the **DESCRIPTION** column provides a brief description of each terminal;
- the **v(V)** column shows the terminal voltage (the hyphen “-” indicates that the voltage cannot be specified for the terminal concerned);
- the **i(A)** column shows the maximum current (in Amperes) that can circulate on the terminal (the hyphen “-” indicates that the current cannot be specified for the terminal concerned);
- the numbers in brackets refer to the following notes.

- (1) The total current draw of Control Panel terminals [+A], [+N], [+B], [+F], [+] and [RED] must not exceed:
 - 430 mA on **ABS16P15** and **ABS42P15**, **ABS16P35** and **ABS42P35**;
 - 1,250 mA on **ABS16M35**, **ABS42M35**, **ABS104M35**, **ABS42M60** and **ABS106M60**.

- (2) The voltage on the [+A], [+N], [+B], [+F] and [+] terminals, under normal operating conditions, can change from 13.8 to 13.6 V. The output voltage below which a Fault event is generated is 12.2 V.

- (3) The voltage on the [RED] terminals, under normal operating conditions, can change from 13.8 to 13.4 V.

- (4) The max. voltage admitted on the changeover switch contacts is **15 V @ 2 A** (Max. switching power **30 W**).

N.	ADDRESS																																					
	1	2	3	4	5	6	7	8	9	10	11	12	13	14	15	16	17	18	19	20	21	22	23	24	25	26	27	28	29	30	31	32						
1																																						
(1) 2																																						
(2) 3																																						
(3) 4																																						
(4) 5																																						

Table 5 Assignment of addresses: column **N.** shows the microswitch numbers (refer to the number in parentheses for the power feeding supply address settings); a **white** square indicates that the respective microswitch must be OFF and a **gray** square indicates that the respective microswitch must be ON.

Ter.	DESCRIPTION	v(V)	i(A)
NC	Programmable Output n. 1	(4)	2
COM	(changeover switch contacts)		
NO			
+N	Programmable Output n. 1 (intrinsic security), protected by fuse	13.8 (2)	1.5 (1)
+A	Programmable Output n. 1 (positive), protected by fuse	13.8 (2)	1.5 (1)
+B	Positive power supply to peripherals, protected by fuse (will be powered by the battery during Mains failure)	13.8 (2)	1.5 (1)
⌚	Negative	0	-
O1	Programmable Output n. 2 (Open-Collector)	0	0.1
O2	Programmable Output n. 3 (Open-Collector)	0	0.1
AS	10 KΩ Supervised Tamper Line	-	-
	Terminals for the Audio Station:		
RED	Positive protected by fuse	13.8 (3)	0.5 (1)
BLK	Negative		
SPK	Speaker		
MIC	Microphone		
	BPI bus for the BPI peripherals:		
+	Positive protected by fuse	13.8 (2)	1.5 (1)
C	Command		
R	Response		
-	Negative		

Ter.	DESCRIPTION	v(V)	i(A)
	KEY bus for the Wireless Receiver:		
RED	Positive protected by fuse	13.8 (3)	0.5 (1)
BLK	Negative		
YEL	Receiver		
GRN	Data		
+F	Power supply to detectors (positive), protected by fuse (will be powered by the battery during Mains failure)	13.8 (2)	1.5 (1)
T1	Terminals programmable as Input Line or Output.	-	-
T4			
L1	Programmable Input Line	-	-
:			
L4			
⌚	Negative	0	-
LE	External telephone line terminals	-	-
LI	Line-sharing devices terminals (for Answerphone, telephone, fax, modem, etc.)	-	-
⊥	Earth Terminal	0	-

At default, inputs L1, L2, L3 and L4 are programmed to signal the following events:
 L1 = Detector fault
 L2 = Hold-up device fault
 L3 = Internal siren fault
 L4 = External siren fault.
 In order to comply with the EN50131-3 and EN50131-1 standards, these settings must NOT be changed.

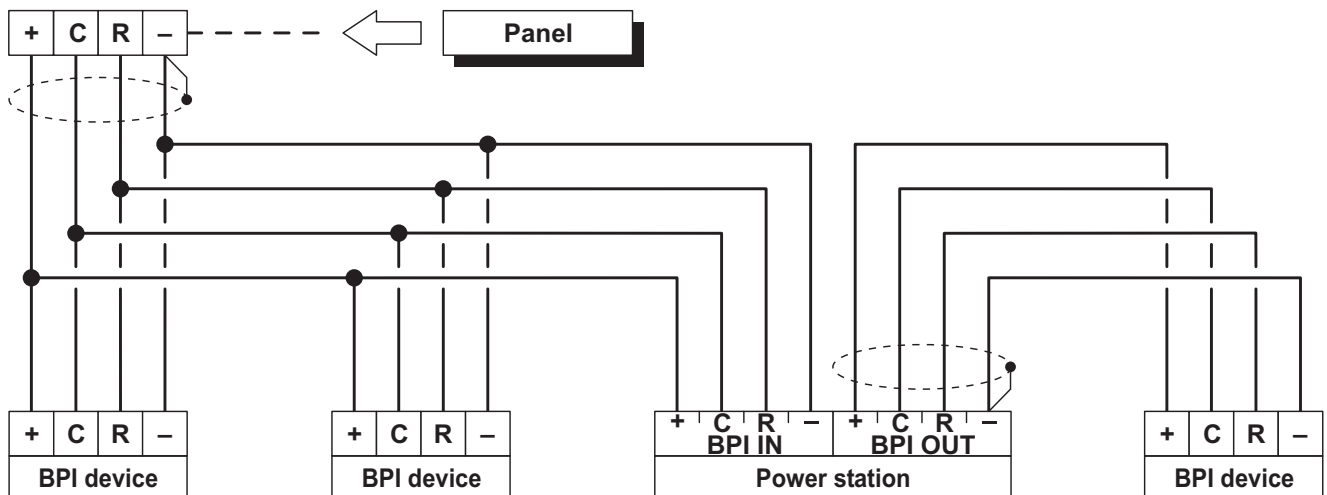



Figure 7 Connection of 4 BPI Devices

Wiring

The section describes how to wire the Control Panel, BPI bus peripherals and various security devices. Each wiring diagram refers to a specific type of device (BPI bus devices, Detectors and Signalling devices).

 Use shielded cable for all connections, with one end connected to negative and the other floating.

 **The end of the stranded conductor must not be soldered in places where it is subject to contact pressure.**

 **The Mains wiring must comply with the rules for double or reinforced insulation.**

 Use an adhesive cable grip to secure the wires to the terminal boards.

The wiring diagrams show some of the many tailored solutions this system provides.

About the Wiring Diagrams The locations of the terminals in the wiring diagrams may be different to those on the board.

- The Zone terminals may belong to the Control Panel, the Keypads or the Input/Output Expanders;
- The Output terminals may belong to the Control Panel or the Input/Output Expanders;
- the Input zone and the Open-Collector Output terminals (in the wiring diagrams) can be found on the Main Unit or Expanders;
- only the terminals required for the connection are shown in the wiring diagrams.

Connecting BPI Bus Devices

The BPI bus supports the following devices:

- LCD Keypads
- Touch Keypads
- Key Readers
- Input Expanders
- Output Expanders
- Power stations

The maximum number of devices supported depends on the type of control panel, as shown in Table 1 on page 6.

Electrical Connections The BPI bus devices must be connected in parallel to terminals [+], [C], [R], [-] on the Main Unit, as shown in Figure 7.

The Power Station has two groups of terminals for the BPI bus connection: the **BPI-IN** group — for the Power Station; and the **BPI-OUT** group — for the BPI devices connected downstream of the Power Station.

The two groups of terminals are electrically isolated, therefore, all the cables and devices connected downstream of the Power Station will not load the Control Panel BPI bus.

Refer to the Power Station Instructions leaflet for further details.

 Only one Power Station can be connected to each shunt of the Control Panel BPI bus (see Fig. 8).

Assigning Addresses You must assign an Address to each of the BPI bus devices. The assigned Address will allow the Control Panel to distinguish one device from another. The Peripheral devices are divided into types: Keypads, Readers, Input/Output Expanders and Power Stations.

Devices of the same type (e.g. two Readers) must have **different Addresses**.

Devices of different types (e.g. a Keypad and a Reader) are intrinsically different, therefore, may have the **same Address**. The BPI bus peripheral Addresses can be assigned in any order.

Table 5 shows the configuration of microswitches for the assignment of addresses to the Input/Output Expansions, the Readers, and the Power Feeding Stations: read the keypads' instructions in order to set their address.

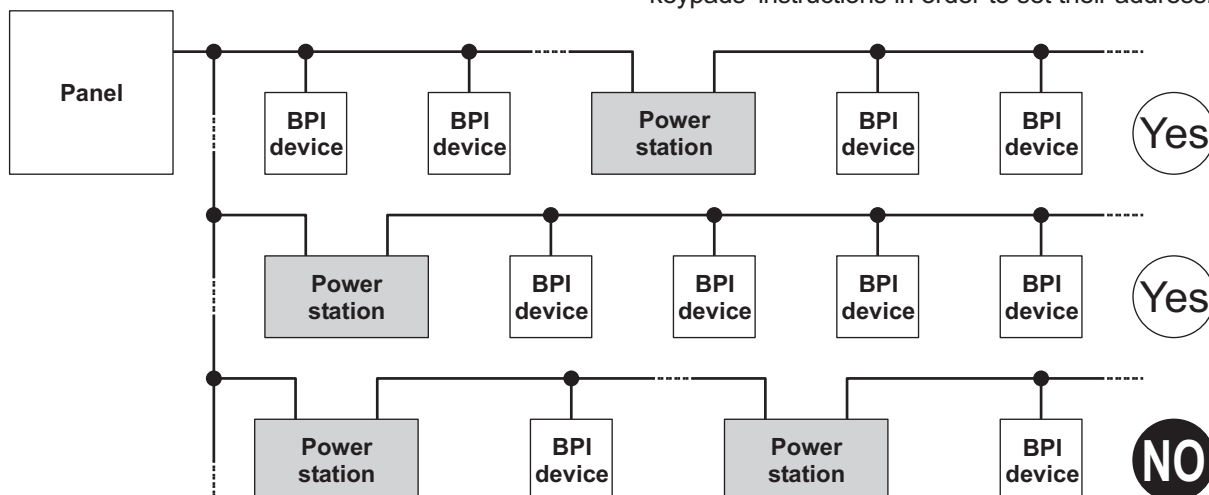

Figure 8 Connecting a Power Station.

Setting the BPI Level The BPI Level determines the maximum voltage the BPI bus can carry. Some BPI devices have 5 V and 12 V options.

This Control Panel operates at 12 V, therefore, all the peripheral devices must be set at 12 V.

Refer to the BPI device instructions for the BPI Level setup.

■ BPI bus Wiring Limitations

Due to Voltage drops and stray capacitance caused by the Control Panel BPI bus connections, the following wiring limitations must be respected:

- the maximum wire length between the **Control Panel** and the BPI peripheral must not exceed **500** metres;
- the overall wire length of the **Control Panel** BPI bus must not exceed **1000** metres.

In order to allow the BPI peripherals to operate properly, **11.5 V** or more must be present across terminals [+] and [-]. If a lower voltage is present, it can be boosted by:

- increasing the wire size that supplies the Control Panel BPI device (the wires that connect [+] and [-] of the Control Panel to terminals [+] and [-] of the BPI device);
- connecting some of the BPI peripherals downstream of a Power Station (these devices will be powered by the Power Station, therefore, will not load the Control Panel BPI bus);
- using a Power Station to provide the voltage for the BPI peripheral load.

The cable length downstream of a Power station should not to be included the overall wire length for the Control Panel BPI bus.

Connecting Detectors

You can connect the detectors to:

- terminals L1, L2, L3 and L4 of the Control Panel;
- terminals T1, T2, T3 and T4 of the Control Panel, if programmed as Input Lines (Zones);
- terminals T1, T2 and T3 of the **T-Line** and **PREMIUM** keypads, depending on the programmed operating mode (refer to the keypad instructions for more information);
- terminals T1, T2, T3, T4, T5 and T6 of the Input/Output Expander M-IN/OUT, depending on the programmed operating mode (refer to the M-IN/OUT's instructions for more information).

The following terminals can be used for the power supply to the detectors.

- [+F] and [↗] (negative) for each pair of Input Lines (Zones) on the **Control Panel**: 13.8 V positive is present on [+F] terminals — protected by resettable fuse (0.4 A).
- [+F] and [↗] (negative) for each pair of Input Lines (Zones) on the **M-IN/OUT** Input/Output Expander: 13.8 V positive is present on [+F] terminals — protected by resettable fuse (0.4 A).
- [+F] and [-] (negative) for three Input Lines (Zones) on the **T-Line** and **PREMIUM** Keypad: 13.8 V positive is present on [+F] terminal — protected by resettable fuse (0.4 A).

Each zone can support several detectors. However, if more than one detector is connected, the Control Panel will be unable to identify the detector in the event of an Alarm.

The Control Panel can detect Alarm, Tamper and Short-circuit on hardwired zones:

- Zone Alarm will be signalled by an **Alarm on zone** event;
- Zone Tamper will be signalled by a **Tamper on zone** event;
- Short-circuit will be signalled by a **Tamper on zone** event.

Resistance	BALANCE TYPES (SUPERVISION)			
	NO	NC	SEOL	DEOL
∞	STANDBY	ALARM	ALARM	TAMPER
10 K	ALARM	ALARM	STANDBY	ALARM
5 K	ALARM	ALARM	SHORTED	STANDBY
0	ALARM	STANDBY	SHORTED	SHORTED

Table 6 Balance Types: the **Resistance** column shows the resistance across the Zone terminal and the Negative during the corresponding status (∞ indicates that the terminal is open; 0 indicates that the terminal is shorted to negative).

The Zone status depends on several parameters (refer to “Hardwired Zones” in the “PROGRAMMING FROM PC” section). This section refers to the Balance type. If only this parameter is considered, the zone status will depend on the resistance between its terminal and negative, as shown in Table 6.

The following paragraphs describe the connections of various types of detectors.

The 10 KΩ resistors are included in the Resistor pack.

The 10 KΩ resistors have brown, black, orange and gold bands. The last band (gold) indicates the tolerance, and therefore, may be a different colour.

■ Connecting Motion Detectors

Most Motion detectors have Normally-Closed Contacts (**NC** in the wiring diagrams), and Normally-Closed Tamper Contacts (**AS** in the wiring diagrams).

The wiring diagram depend on the selected supervision. This Control Panel supports the following supervision:

- Normally Open;
- Normally Closed;
- Single End Of Line Resistor (SEOL);
- Double End Of Line Resistor (DEOL).

Figures 9, 10 and 11 show the wiring diagram for each Supervision type. In these figures:

- [+] and [-] terminals represent the positive and negative terminals;
- [NC] terminals are the Normally Closed Alarm Contacts of the detector;
- [AS] terminals are the Normally Closed Tamper Contacts of the detector.

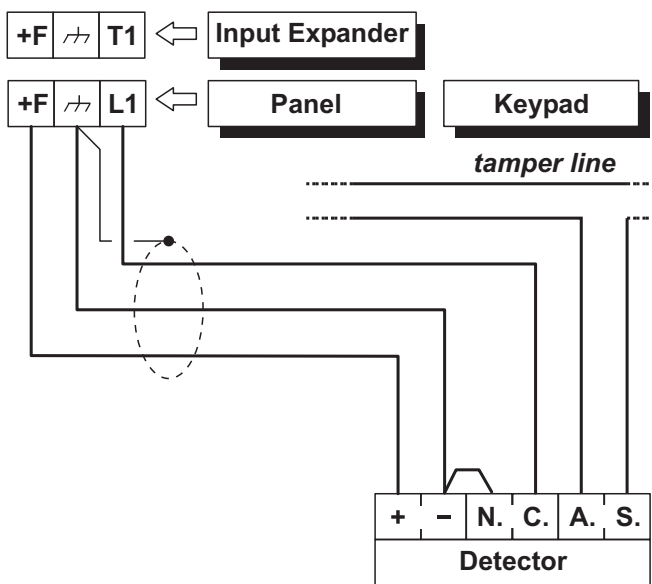

Figure 9 Connecting a Detector to a zone with Normally Closed supervision.

Normally Closed The wiring diagram in Figure 9 illustrates the connection of a detector to a Zone with Normally Closed supervision.

Normally Closed supervision will allow the Control Panel to detect Alarm status on the zone:

- the zone will hold Standby status whilst connected to negative;
- the zone will trigger Alarm under all other conditions.

To provide Tamper detection on zones with Normally Closed supervision:

- either connect the detector tamper contact to the Control Panel Tamper Line — this type of connection does not provide identification of the tampered detector;
- or connect the detector tamper contact to a 24h zone — this type of connection requires two zones — one for Alarm detection, and the other for Tamper detection (refer to “Connecting Tamper Contacts”).

SEOL The wiring diagram in Figure 10 illustrates the connection of a detector to a Zone with SEOL supervision.

The 10 KΩ resistor must be connected to the last detector of the zone.

SEOL supervision will allow the Control Panel to detect Alarm and Short-circuit on the zone:

- the zone will hold Standby status when connected to negative via a 10 KΩ resistor;
- the zone will trigger short-circuit when connected to negative;
- the zone will trigger Alarm under all other conditions.

To provide Tamper detection: connect the Tamper contact of the detector to the Control Panel Tamper Line, or to a 24h zone (refer to “Connecting Tamper Contacts”).

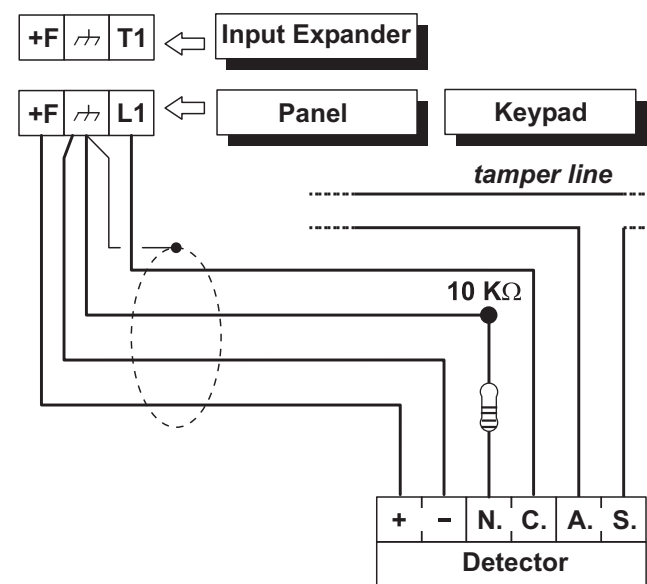

Figure 10 Connecting a Detector to a zone with SEOL supervision.

DEOL The wiring diagram in Fig. 11 illustrates the connection of a detector to a Input Line (Zone) with DEOL supervision.

The 10 KΩ resistors must be connected to the last detector of the zone.

DEOL Supervision will allow the Control Panel to detect zone Alarm, Tamper and Short-circuit:

- the zone will hold Standby status whilst connected to negative via a 5 KΩ resistor (i.e. using two 10 KΩ resistors connected in parallel);
- the zone will trigger short-circuit when connected to negative;
- the zone will trigger Tamper when open;
- the zone will trigger Alarm under all other conditions.

Zones with DEOL supervision can detect and signal Alarm and Tamper by means of just two wires.

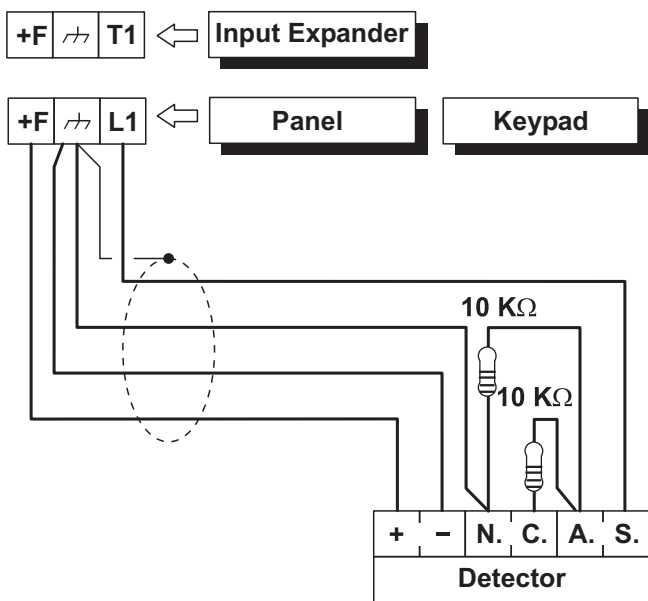

Figure 11 Connecting a Detector to a zone with DEOL supervision.

■ Connecting Roller-Blind and Vibration Detectors Zones 1 through 8 of ABSOLUTA support Roller-blind and Vibration detectors. The zones must be programmed respectively with either the Vibration or Roller-blind option (refer to the 'PROGRAMMING', Hardwired zones, in this Manual), and can be set up as **Normally Closed, SEOL** or **DEOL** supervision. The wiring diagram in Figure 18 shows a typical connection.

The 10 KΩ EOL Resistor must be connected to the last device.

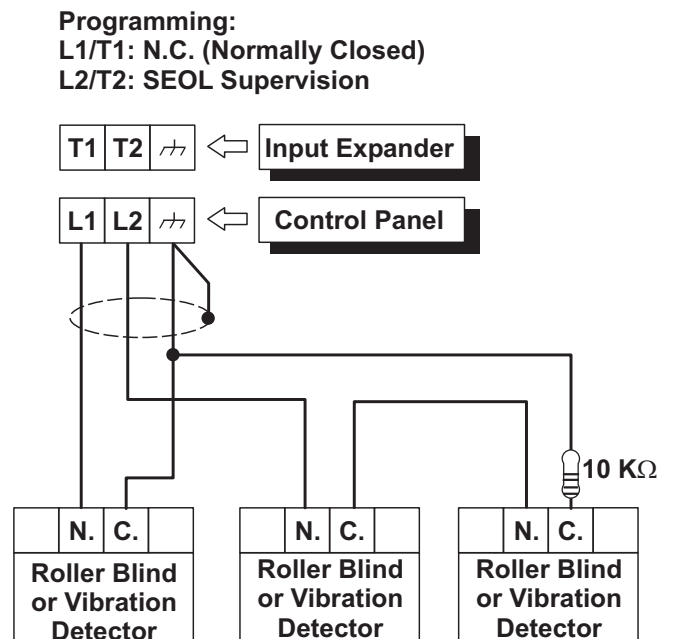



Figure 12 Connecting Vibration Detectors and Roller Blind contacts: connecting one detector to a Normally Closed zone and connecting two detectors to a SEOL Supervision zone.

■ Connecting Fire Detectors

The ABSOLUTA can also manage Fire detectors that can operate with a supply voltage of 12 V and are equipped with alarm repeat outputs (such as BENTEL SECURITY 600/ZT100 Series). The Fire detectors can be connected using the MUB-RV relay base. Alternatively, connect the Alarm Repeat outputs of the Fire detectors [R]/[3] to an Input Zone programmed as **Fire (Normally Open and 24h)**, inserting a diode in series as shown in Figure 13 (600 series ONLY). Connect the detector positive [L1]/[2] to terminal [+F], and connect the detector negative [L]/[5] to an open-collector output.

The open-collector output must be programmed as **Monostable, Normally Closed, 20 seconds ON Time** and assigned to an event that will reset the Fire Detectors (e.g. Control Panel Reset or Partition Reset). The connections described result in the power supply to the Fire Detectors being cut off for 20 seconds each time the event occurs, thus allowing the detectors to reset.

 *Inputs connected to fire detectors do not meet the EN50131-1 and EN50131-3 standards as they are not covered by the same standards.*

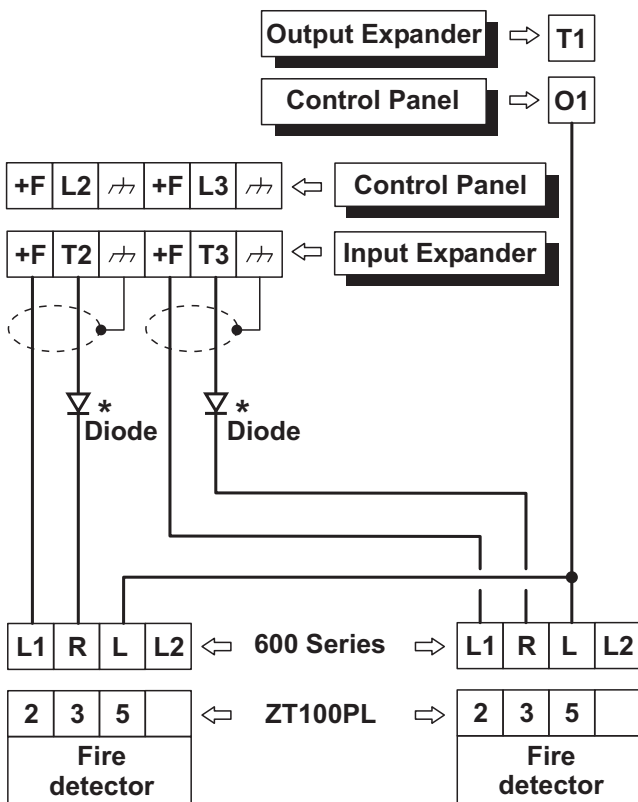



Figure 13 Connecting 2 Fire Detectors to a Zone with Normally Open supervision (* with series 600 ONLY).

Connecting Alarm Signalling Devices

 The panel, to comply the EN50131-1 and EN50131-3 standards, supports the following notification options:

- A) 2 sirens with remote power supply + panel built-in telephone communicator;
- B) 1 self-powered siren + panel built-in telephone communicator;
- C) panel built-in telephone communicator + external telephone communicator with at least ATS-1 grade performance, according with the EN50131 and EN50136-1-1-1 standards;
- D) external telephone communicator with at least ATS-3 grade performance, according with the EN50131 and EN50136-1-1-1 standards.

The ABSOLUTA Control Panel is equipped with three outputs to connect the Alarm Signalling Devices:

- the terminals NC, COM, NO, +N and +A are relevant to the output no. 1;
- the terminal O1 is relevant to the output no. 2;
- the terminal O2 is relevant to the output no. 3.

 At default, The O2 open-collector output is active in case of trouble. If this setting is not changed, to maintain compliance with the EN50131-1 and EN50131-3 standards, you must NOT connected additional and self-powered sirens to this output.

Alternatively, you can connect the Alarm Signalling Devices to:

- terminals T1, T2, T3 and T4 of the Control Panel, if programmed as Outputs;
- terminals T1, T2, T3, T4, T5 and T6 of the Input/Output Expander M-IN/OUT, depending on the programmed operating mode (refer to the M-IN/OUT's instructions for more information).

Alarm Signalling Devices, such as: Self-Powered Sirens, Indoor Sirens, Telephones Diallers, etc., can be classified as follows:

- **Intrinsic Security Devices** (e.g. Self-Powered Sirens) activated by voltage failure on the respective terminal;
 - **Positive Alarm Line** devices (e.g. Indoor Sirens) activated by positive (12 V) on the respective terminal;
 - **Negative Alarm Line** devices activated by negative (0 V) on the respective terminal;
 - **Supervised Alarm Line** devices activated by impedance unbalance on the respective terminal.
- The wiring diagram depend on the Alarm Signalling Device to connect.

The wiring diagram in Figure 14 illustrates connection of a Self-powered Siren and an Indoor Siren to Output no. 1 on the Control Panel:

- Output no. 1 on the Control Panel is programmed as Normally Closed;
- **[+N]** is the positive power and Input of the Self-powered Siren. The Siren will activate when positive (13.8 V) fails on the [+N] terminal;
- **[+B]** is the positive power and Input of the Indoor Siren. The Siren will activate when positive (13.8 V) is applied to the [+B] terminal;
- **[+]** and **[GND]** are the negative power terminals of the Self-powered Siren and Indoor Siren;
- **[A.S.]** and **[AS1-AS2]** are the Normally Closed Tamper contacts of the Self-powered Siren and Indoor Siren.

To provide Tamper detection: connect the Signalling device Tamper contact to the Control Panel Tamper Line or to a 24h zone (refer to "Connecting Tamper Contacts").

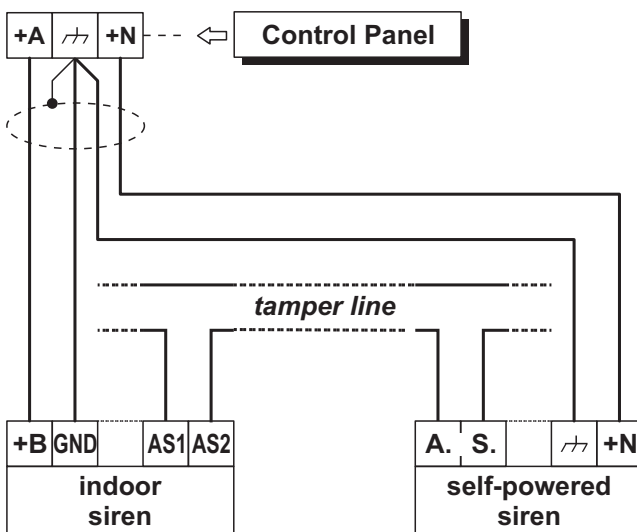



Figure 14 Connecting a Self-powered Siren and an Indoor Siren to Control Panel Output no. 1.

■ Supervised Output

Output no. 1 can be set up as Supervised Output. This type of output must be programmed as Normally Closed (refer to “Attributes” under “Outputs” in the “PROGRAMMING” section). The Control Panel can detect short-circuit and connection interrupt to terminals +A of output with this attribute. The wiring diagram in Figure 15 illustrates the connection of an Indoor Siren to the Supervised Output using a 2.2 K Ω across terminals +A and negative.

The 2.2 K Ω resistor (included in the package) have 3 red bands and a gold band. The last band (gold) indicates the tolerance, therefore, it may be a different colour.

 The 2.2 K Ω resistor must be connected to the last device on the Output, otherwise it will have no effect.

Short-circuit and connection interruption to terminal +A of Supervised Output, will be signalled by:

- **Tamper on supervised output** — relative to the Output;
- flashing on the  indicator on the Keypads.

Connecting Tamper Terminals

The Tamper contacts of the security system devices can be connected to the SEOL Supervised 24h Tamper Line.

The Tamper Line terminal is marked **AS**:

- The Tamper Line will hold Standby status when connected to negative via a 10 K Ω resistor;
- The Tamper Line will trigger an Alarm under all other conditions.

Alarm on the Tamper Line will be signalled by:

- a **Tamper on Main unit** event (by default, to comply with EN50131, the **Tamper on External Siren** event will occur);
- flashing on the **T** indicator on Keypads.

 The **T** indicator will flash until the cause of Alarm is cleared (memory). The **T** indicator will stop flashing when the Control Panel resets.

The wiring diagram in Figure 16 illustrates the connection of 3 Tamper contacts to the Control Panel Tamper Line:

1. connect the device tamper contacts in series;
2. connect a 10 K Ω resistor in series to the last Tamper contact;
3. connect one end of the series to the [AS] terminal and the other to the [A.] terminal.

 The 10 K Ω resistor must be connected to the last device on the tamper line. If the Tamper line is not used, connect a 10 K Ω resistor across terminals [AS] and [A.]

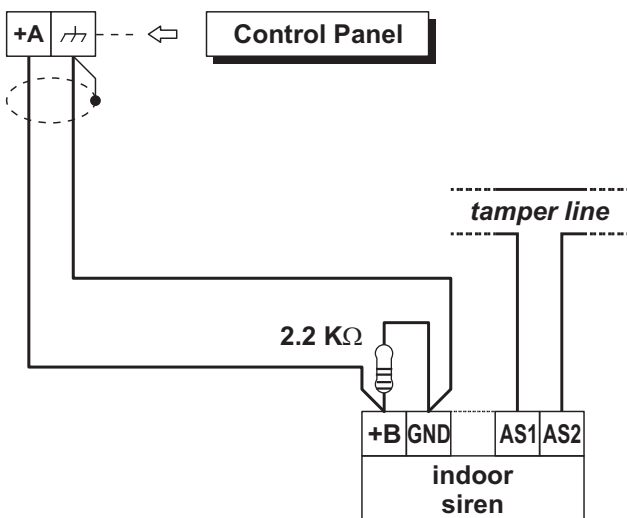

Figure 15 Connecting an Indoor Siren to a Supervised Output on the Control Panel.

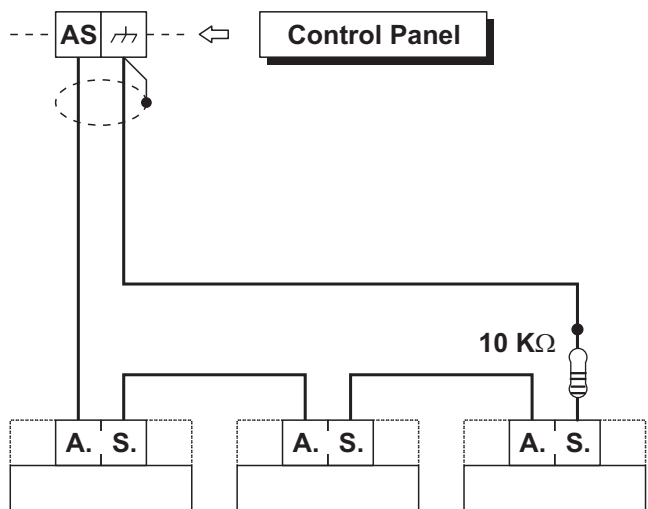

Figure 16 Connecting 3 Tamper contacts to the Control Panel Tamper Line — the [A.S.] terminals represent the Normally Closed Tamper contacts of the device.

☞ If several contacts are connected to the Tamper Line, the tampered device will be unidentifiable.

To identify tampered devices:

- select **DEOL** Supervision for motion detector connections (refer to “DEOL” under “Connecting Motion Detectors”);
- connect each Tamper contact to a 24h zone with SEOL Supervision (see Figure 17).

☞ Tamper contact zones can be programmed with Normally Closed Supervision, in which case, the 10 KΩ resistors must not be connected.

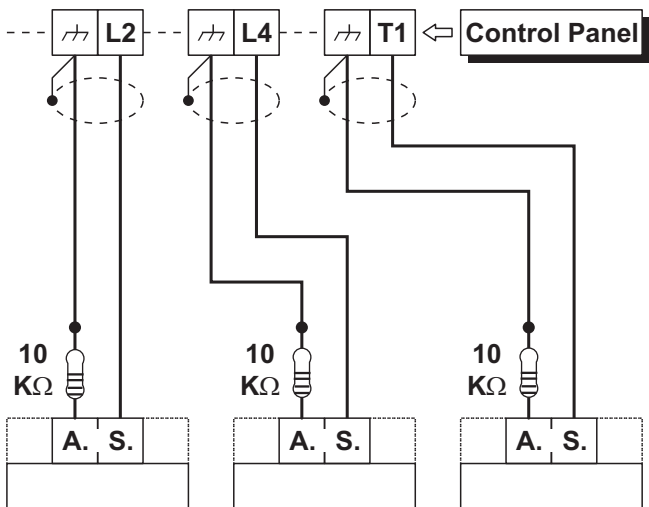

Figure 17 Connecting 3 Tamper contacts to three 24h Zones with SEOL Supervision — the [A.S.] terminals represent the Normally Closed Tamper Contact of the device.

Connecting the Telephone Line

In order to allow use of the Dialler, Digital communicator and Teleservice facilities, the telephone line must be connected to terminals [LE], as shown in Figure 18.

☞ In order to comply with the EN50131-1 and EN50131-3 standards, the Vocal Telephone Dialler and/or the Digital Communicator must be enabled.

The Control Panel can detect Telephone line trouble (Line down), which will be signalled when the voltage on the [LE] terminals drops below 3 V for over 45 seconds.

Telephone line trouble will be signalled by:

- the **Line-down** event;
- ON status of the ▲ indicator on Keypads;
- flashing on the 🔄 indicator on Keypads.

The Control Panel will signal restoration when the voltage on the [LE] terminals returns to 3 V for over 15 seconds.

☞ If the telephone line **IS NOT CONNECTED** to the Panel, the Telephone **Line check** option must be **DISABLED**. If it is not Disabled, the Control Panel will signal Line-down status persistently (refer to “PSTN options” in the “PROGRAMMING FROM THE PC” section). By default this option is disabled.

Connect Line-sharing devices (Fax, Answerphone, etc.) to the [LI] terminals. This will allow the Control Panel to take priority ONLY in the event of an alarm. Connect the [⚡] terminal to the Mains Earth — this will protect the PCB against surges from the Telephone line.

⚠ Ensure that the Mains Earth is fully intact and operating properly before connecting the Telephone line.

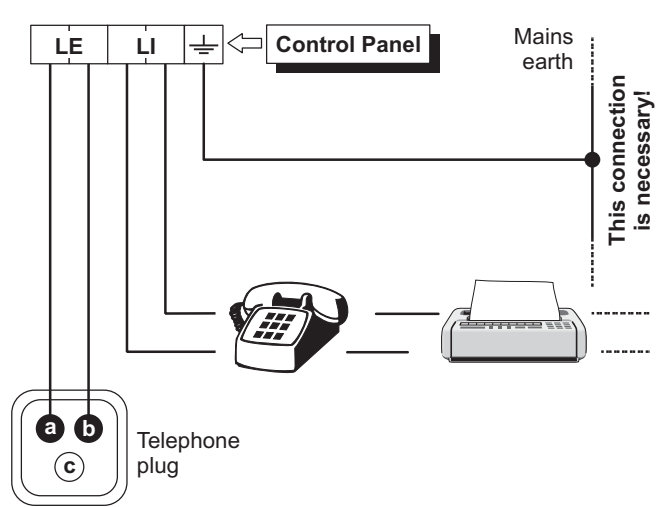

Figure 18 Connecting the Telephone Line to the Control Panel.

Connecting the AS100 Audio Station

The **AS100** (accessory item) is a 2-way audio station that include a speaker and a microphone.

By means the **AS100**:

- the Installer can record and playback the Voice Messages (refer to “2.1 Voice Message Recording” in the “KEYPAD OPERATION” section);
- the User can perform some audio functions by a remote telephone (refer to “OPERATING THE SYSTEM FROM A TELEPHONE” in the User Manual);
- the user can have an audio feedback on the security system status (refer to “Event and Actions” in the “PROGRAMMING FROM THE PC” section).
- the Central Station operator can perform an audio verification of the alarm event.

 This Control Panel support ONE AS100.

Refer to the diagram in Figure 19 for the connection of the AS100 to the Control Panel's Main Board.

 The audio station AS100 is NOT certified IMQ-SECURITY SYSTEMS and therefore does not conform to the EN50131-1 and EN50131-3 standards.

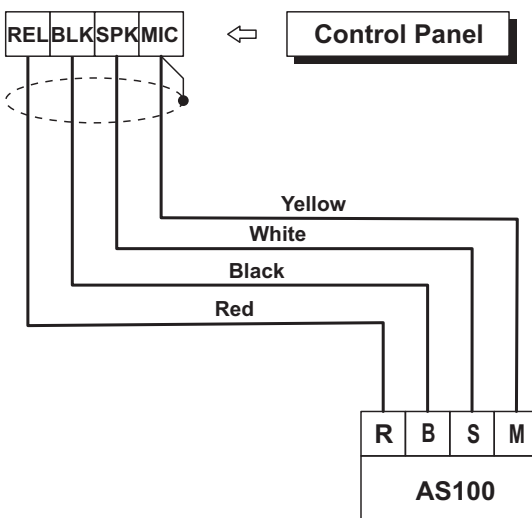



Figure 19 Connecting the AS100 to the Control Panel.

Power Supply

 In order to comply with the Safety regulations in force, the Mains must be equipped with a bipolar isolating device for protection against over voltage and short-circuit to Earth (e.g. automatic isolating switch).

The ABSOLUTA is powered from the Mains (230V/50 Hz) through a Switching power supply, located inside the cabinet. The cabinet can also house a backup battery (not included) for power backup during Mains failure.

Mains failure will be signalled by the:

- OFF status of indicator on the Power Supply;
- ON status of the ▲ indicator on Keypads;
- **Warning Mains failure** event.

 The **Warning Mains failure** event will be signalled after the programmed delay (refer to “Filter Times” in the “PROGRAMMING FROM PC” section).

The panel reports a fault when the output voltage drops below 11.2 V, with:

- ON status of the ▲ indicator on Keypads;
- the message Panel low Vout on the LCD Keypads, in View Signals mode.

The Control Panel will monitor the battery at all times, (refer to **Static Test** and **Dynamic Test**).

Static Test The **Static** Test monitors the battery charge during Mains failure. **Low battery** status (below 11.4 V) will be signalled by the:

- **Low battery** event;
- ON status of the ▲ indicator on Keypads.

If this occurs, the Mains power must be restored before the battery empties, otherwise, the system will shutdown.

Low battery restoral (over 12.3 V) will be signalled by:

- the end of the **Warning low battery** event;
- The ▲ indicator on Keypad turn OFF only after the reset of all events (the events stay in memory).

 The Control Panel automatically shuts down when the battery voltage drops below 9.6 V to protect the battery from permanent damage.

Dynamic Test The **Dynamic** Test monitors the operating capacity of the battery. A failed test (battery does not meet the Test requirements) will be signalled by the:

- **Warning power trouble** event;
- ON status of the ▲ indicator on Keypads.

If this occurs, the backup battery must be replaced immediately, otherwise, the system will be unable to function in the event of Mains failure (black-out).

Battery trouble restoral will be signalled by the:

- end of the **Warning power trouble** event;
- The ▲ indicator on Keypad turn OFF only after the reset of all events (the events stay in memory).

■ Power connection

Work carefully through the following steps (refer to “Parts Identification”).

1. Locate the backup battery on its housing **33**.
2. Connect the backup battery to the connector **13** on the Main Board, by means the cable **30**.
3. Connect the **Earth** wire to the [⊕] terminal on the power supply terminal board.
4. Connect the Neutral wire to terminal [N], and the Line wire to terminal [L] on the power supply terminal board.

The Control Panel Tamper Switch is enabled by the initial closure of the Control Panel. Therefore, it cannot trigger a **Tamper on Panel** event on first power up. Likewise, if the Panel is opened during a programming session (via Keypad or computer), the Tamper switch will be inhibited thus unable to trigger a **Tamper on Panel** event until the Programming session ends, and the Panel is closed again.

■ Power disconnection

To disconnect the power, proceed as described below (see “IDENTIFICATION OF PARTS” on pages 13, 14 and 15).

1. Disconnect the **Neutral [N]** and **Line [L]** on the Power-Supply terminal board.
2. Disconnect the **Earth** wire [⊕].
3. Wait for the control panel to signal the lack of main voltage, with:
 - the keypad light indicator **▲**;
 - the message **Panel NO 220v** on the keypads, in *view signals mode* (see “View Signals” in the USER MANUAL).
4. Disconnect backup battery cable **30** from connector **13** of the Motherboard.

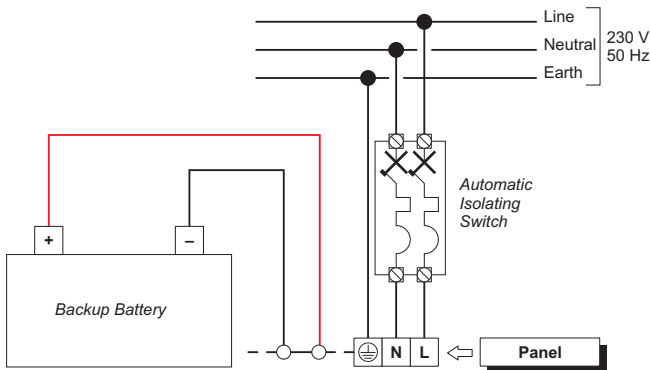

Figure 20 Connecting the Mains power.

■ Auto-configuration (Wizard setup)

Each time you power up the control panel, the LCD keypads will show the following message, for approximately 15 second, indicating that the Control Panel is performing the Auto-configuration:



If you are performing the Hardware Default, the LCD Keypads show the message “RemoveJumpPCLink” that remember to you to remove the short circuit on the PC-LINK connector (refer to “Hardware Default” for further details).

During this phase the Control Panel will enroll the BPI Bus peripherals.

Termination of this phase will be indicated on the LCD Keypads as follows:



Press **ENTER** **once** and wait a few moments for the next message to appear: the time taken will depend on the number of devices connected to the BPI bus.

1. When you press **ENTER**, the display will show the available languages:



2. Select the required language by enter the relative number:

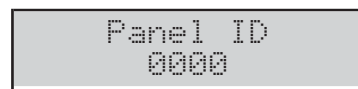

3. Enter the Panel ID then press **ENTER**:



The LCD keypads will show the enrolled BPI devices as follow:

- **Kb** are the Keyboards;
 - **Kr** are the Key readers;
 - **AI** are the Power Stations;
 - **Ei** are the Input Expanders;
 - **Eo** are the Output Expanders.
4. Press **ENTER** if the display configuration is right and go to the next step, or check the connection and the address of the missed BPI peripherals, then press **OFF** and **ESC**, and go back to the step 1.

```
Zone Term. 000
----- Board
```

The top line shows the available zones (Zone Term.)

The bottom line shows the standby status and the supervision relevant to the zones on the device indicated on the right side, as follow:

- -, the zone is not used;
- **O**, the zone is Normally Open, Not Supervised;
- **C**, the zone is Normally Closed, Not Supervised;
- **D**, the zone is DEOL (Double End Of Line) Supervised;
- **r**, the zone is Reserved;
- **S**, the zone is SEOL (single End Of Line) Supervised;
- **X**, the relative terminal is an output;
- **Board** are the zones on the Main Board;
- **Ein01** are the zones on the Input Expander 01.

5. Press the number relative to a Zone to change its standby status and supervision option: press 1 for zone terminal T1, 2 for zone terminal T2 e so on; press the number until the display shows the required option.
Press the key **A** or **B** to change the options for all terminals.
Press the key **C** or **D** to select the device.
Press **ENTER** when the display shows the required standby status for each zone:

```
Delayed Zone 000
iiiiiii Board
```

The top line shows the number of Delayed Zones.

The bottom line shows the status of the Delayed Option for each zone on the device indicated on the right side, as follow:

- -, the zone is not used;
- **i**, the zone is Instant;
- **r**, the zone is Reserved;
- **D**, the zone is Delayed;
- **M**, the zone has been Modified by BOSS;
- **Board** are the zones on the Main Board;
- **Ein01** are the zones on the Input Expander 01.

☞ *The **r** letter next a zone indicates that it is reserved. These reserved zones are set as **Hold-up, Zone Fault, Internal Siren Fault and External Siren Fault.***

☞ *The **M** letter next to a zone indicates that the zone's delay options (Entry Delay and **Exit Delay**) were changed by BOSS, in a configuration DOES NOT supported by the Wizard Setup then NOT modifiable by the Wizard Setup.*

6. Press the number relative to a Zone to change its Delayed option: press 1 for zone terminal T1, 2 for zone terminal T2 so on; press the number until the display shows the required option.
Press the key **C** or **D** to select the device.
Press **ENTER** when the display shows the required Delayed option for each zone:

```
Int. Zone 000
IIIIIII Board
```

The top line shows the number of Internal Zones.

The bottom line shows the status of the Internal Option for each zone on the device indicated on the right side, as follow:

- -, the zone is not used;
- **I**, the zone is Internal;
- **r**, the zone is Reserved;
- **E**, the zone is NOT Internal (Normal);
- **Board** are the zones on the Main Board;
- **Ein01** are the zones on the Input Expander 01.

7. Press the number relative to a Zone to change its Internal option: press 1 for zone terminal T1, 2 for zone terminal T2 e so on; press the number until the display shows the required option.
Press the key **C** or **D** to select the device.
Press **ENTER** when the display shows the required Internal option for each zone:

```
Sep/09/09 09:14
Enter PIN
```

The top line shows date and time and the bottom line shows Enter PIN, indicating the end of the wizard setup.

☞ *The configuration can be changed during the programming session.*

TEMPERATURE (°C)	-10	-5	0	5	10	15	20	25	30	35	40	45	50
VOLTAGE (V)	14.5	14.4	14.3	14.1	14.0	13.9	13.7	13.6	13.5	13.4	13.3	13.2	13.1

Table 7 Switching Power Supply Output Voltage chart. To find the Output Voltage using the chart: — select the nearest value to the Probe temperature on the **TEMPERATURE (°C)** row; read the corresponding value on the **VOLTAGE (V)** row; adjust the Output Voltage of the Switching Power Supply to the indicated value. For example, if the Probe temperature is 22 °C, the Output Voltage of the Switching Power Supply must be set at 13.7 V.

■ Thermal Probe

The Thermal probe **KST** (accessory item) will optimize the backup battery charge process, by regulating the charge voltage in accordance with the temperature of the backup battery.

Work carefully through the following instructions to install the Thermal probe (refer to the figures 2 and 3 on page 14 and 15):

1. Connect the probe to the connector on the power supply.
2. Attach the probe to the backup battery, in such a way as to obtain optimum heat transfer.
3. Measure the Probe temperature.
4. Using the graph in Figure 21 and/or Table 7, find the value (in accordance with the battery temperature) that the Switching Power supply output voltage will be based on.
5. Using the trimmer, adjust the voltage on the terminal board to the required value.

 If you are connecting a KST thermal probe to a BAQ15T12 Power Supply, ensure that the BAQ15T12 on-board Jumper is inserted.

For further information, refer to the Insert in the KST package.

Hardware Default

You can restore the Control Panel options to the factory default by hardware, as indicated below.

You can also restore the factory default by an LCD Keypad (refer to “Factory Default” in the “KEYPAD OPERATIONS” section).

 You **CAN'T** perform the Hardware Default if the option **Lock Installer Code** is enabled (refer to “System options” in the “PROGRAMMING FROM PC” section).

 To reset all the Voice Messages, download the audio file from BENTEL's website onto a USB key and then upload the Voice Messages from the USB key onto the control panel as described in paragraph “2.5) Message Download/Upload via USB Key”.

1. Short circuit the pins 1 and 2 on the PC-LINK connector (10).
2. Remove ALL the control panel power: remove the power supply connector (12) and the battery connector (13).

 The self-powered signalling devices will sound.

3. Re-connect the control panel power: the LCD keypads will show the following message

```
Togli PontPCLink
RemoveJumPCLink
```

4. Remove the short circuit on the PC-LINK connector: the control panel will perform the Wizard Setup (refer to “Auto-configuration (Wizard setup)”).

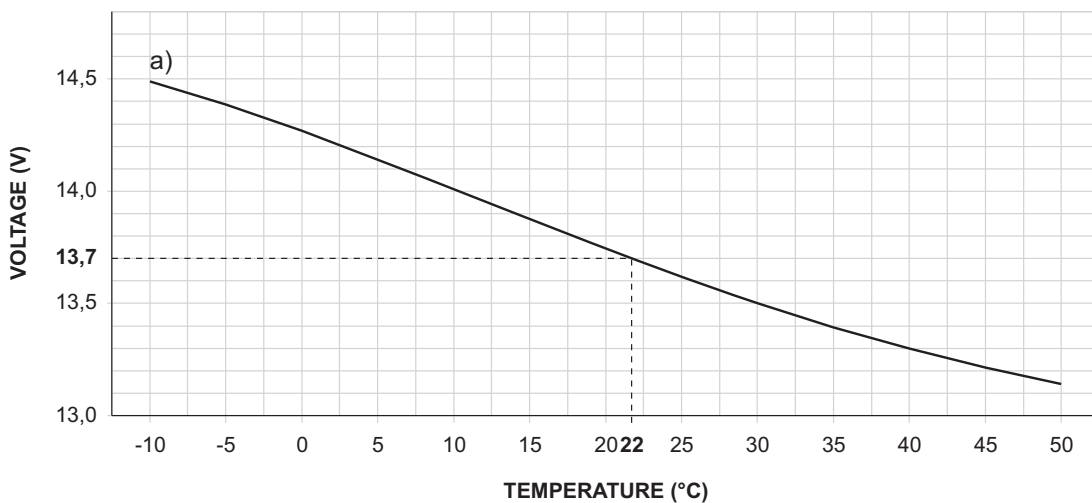

Figure 21 Switching Power Supply Output Voltage graph. To find the Output Voltage using the graph: — indicate the Probe temperature on the **TEMPERATURE (°C)** axis; draw a line from the temperature value point up to the curve **a)**; draw a line from the intersection point across to the **VOLTAGE (V)** axis; adjust the Output Voltage of the Switching Power Supply to the resultant value. For example, if the Probe temperature is 22 °C, the Output Voltage of the Switching Power Supply must be set at 13.7 V.

You can program this Control Panel using the BOSS Console Software that you can download from

www.bentelsecurity.com

Read this section thoroughly to learn how to install and use the **BOSS** Console Software.

1. Install the BOSS Console as described in the Help on line:

www.customer.bentelsecurity.com/boss/eng/

2. Run the BOSS Console Software.
3. Select the Username and enter the corresponding **Password** to **Login** in the relevant session: the default Username is **admin** and the Password is **1234**.
4. Select the **Account Search** option on the **Start Page** menu, then select **New Account** to create a new account or open an existing account.
5. Setup the options (refer to the respective paragraphs for instructions).
6. Download the options to the control panel (refer to "Downloading/Uploading").

The system options are organized in groups. The Option Groups in this section are congruent with the **BOSS** application structure.

■ Options with requirements

 The IMQ/A symbol indicates the option requirements to comply with the EN50131-1 and EN50131-3 standards.

■ Minimum system requirements

To support the prerequisites for BOSS the following system requirements must be met:

- **Processor:** 600 megahertz (MHz) Pentium III compatible or faster processor, 1 gigahertz (GHz) or faster is recommended;
- **RAM:** 1GB of System Memory;
- **Hard Disk:** 2.1 GB of available space;
- **CD or DVD Drive:** Not required;
- **Display:** 1024 x 768 high colour, 32-bit (Recommended).

Configuration

On startup the Control Panel will automatically enroll all the BPI Bus peripherals (refer to “Power supply connection” under “INSTALLATION”). Any changes after automatic enrollment must be made by the Installer.

During the polling process, the Control Panel will **compare** the interrogation result with the stored configuration and, in the event of mismatch, will a warning.

 *If the Control Panel is connected to a computer, it will be possible to view the configuration by uploading the Configuration page.*

The Configuration Group Options is divided into pages — one for each type of device (Keypads, Expander In, Expander Out, Key Readers, Power Stations and Wireless Module).

In the second column, the application shows the list of supported BPI peripherals, for the type selected in the first column: the application shows the peripheral address in bracket followed by the label assigned to.

In the third column you can set the options relevant to the BPI peripheral selected in the second column.

The following programming instructions refer to options common to all BPI peripherals. For instructions on how to program the options of a specific device, refer to the relevant paragraph.

Label This option (maximum 16 characters) is for the device label (e.g. Entrance, Kitchen, etc.). This label will identify the Device in all the operations it is involved in.

Enabled The devices connected to the BPI Bus must be Enrolled, otherwise the Control Panel will be unable to manage them.



Figure 22 Default labels of the Super Keys on the Touchscreen Keypad.

If a peripheral device has not been connected properly to the BPI bus, or fails to respond (Device Lost) due to Trouble or Tamper, an X will be shown above the  icon on the Keypad, and the Control Panel will generate the following event:

➤ Warning BPI Peripheral

 *The event will be recorded in the Log (refer to **ID.TYPE** for the BPI Device Lost event).*

■ Keypads

The **Keypads** option group will allow you to enroll and set up all the options relating to the keypad.

 *For information regarding the **Enabled** and Label options, refer to “Configuration”.*

Type Select the type of keypad: **LCD** or **Touch**.
Default: LCD.

EN50131 If this option is enabled, in standby mode the keypad will hide the Control Panel and zone display status. To display this information, you will have to enter your own PIN first. In the event of Alarms, Tamper, and Troubles, indicator light  will be illuminated, but in order to view malfunction information you will have to enter your own PIN.
Default: enabled.

 *In order to comply with the EN50131-1 and EN50131-3 standards, this option must be enabled.*

SMS Notification Select the type of notification for SMS text messages received by the GSM module:

- **Off**, no notification;
- **Show Alert**, the keypad displays the message SMS received;
- **Show Alter and Sounds**, the keypad displays the message SMS received and beeps (LCD keypads only).

 *This option CANNOT be set if the **GSM** group **Present** option is not enabled.*

Default: Off.

Super Key 1 Enter a label to explain the button  on the Touchscreen Keypad (Figure 22).
Valid values: up to 16 characters.
Default: Panic.

Super Key 2 Enter a label to explain the button  on the Touchscreen Keypad (Figure 22).
Valid values: up to 16 characters.
Default: Emergency.

Super Key 3 Enter a label to explain the button  on the Touchscreen Keypad (Figure 22).
Valid values: up to 16 characters.
Default: Fire.

Partitions Select the Keypad Partitions. The Keypad will be able to control (Arm, Disarm, etc.) ONLY the Enabled Partitions.

 *Keypads need not necessarily be enabled on Partitions, and can be used for programming, viewing and other non-command related purposes.*

■ Expander In

The Expander In option group will allow you to enroll the Input Expanders located on the **M-IN/OUT** Expanders the **PREMIUM** and the **ABSOLUTA T-Line** keypads connected to the BPI bus¹.

 *For information regarding the **Enabled** and **Label** options, refer to “Configuration”.*

Inputs Select the number of inputs on board the device: only the relevant terminals will therefore be displayed in the **Zones** option group.

■ Expander Out

The Expander Out option group will allow you to enroll the Output Expanders located on the **M-IN/OUT** Expanders, on the **PREMIUM** and **ABSOLUTA T-Line** keypads, connected to the BPI bus¹.

 *For information regarding the **Enabled** and **Label** options, refer to “Configuration”.*

Outputs Select the number of outputs on board the device: only the relevant terminals will therefore be displayed in the **Outputs** option group.

■ Key Readers

The **Key Readers** option sub-group will allow you to enroll and set up Key Readers. You must set up the Options and the Arm Modes for each **Partition**, as follow.

 *For information regarding the **Enabled** and **Label** options, refer to “Configuration”.*

EN50131 If this option is enabled, in standby mode the Readers' LED's are turned off, regardless of the Partition status.

Default: enabled.

 *In order to comply with the EN50131-1 and EN50131-3 standards, this option must be enabled.*

Partitions This option will allow you to assign the Reader to the relevant Partition: the Reader will be able to Arm the Partition in Away mode.

 *Commands performed by the selected Key Reader will affect ONLY the Partitions common to both the Reader and Key in use.*

For example, if you attempt to Arm the system at a Reader that is enabled on Partitions no. 1 and no. 2, with a Key that is enabled on Partitions no. 1 and no. 3, ONLY Partition no. 1 will Arm (Partition no. 1 is common to both the Reader and Key).

Yellow This option will allow you to set up the **A Mode** Arming configuration. If an **A Mode** Arming request is made at a Reader, the Partitions will Arm/Disarm in accordance with the programmed configuration, as follows:

- **None** — the status of the corresponding Partition will remain unchanged;
- **Away Arm** — the Partition will Arm;
- **Stay Arm** — the Partition will Arm in Stay mode (i.e. Zones with the **Internal** Attribute will be Bypassed);
- **Instant Stay** — the Partition will Arm in Stay mode with zero Entry Delay;
- **Disarm** — the Partition will Disarm.

Green As per the **Yellow** option but for **B Mode**.

■ Power station

The **Power stations** page will allow you to enroll and setup the Power Stations.

 *For information regarding the **Enrolled** and **Label** parameters, refer to the “Configuration” section.*

AC Fail Delay Set the delay for the MAINS fault on the Power Supply Station before it will be signalled.

Valid entries: 0 through 3600 seconds, in 1 second steps.

Default setting: 0 seconds

 *In order to comply with the EN50131-6 standards, this option MUST NOT be more than 60 seconds.*

¹ The M-IN/OUT Expander is seen as an Input Expander and/or as an Output Expander, depending on how it is programmed (refer to the M-IN/OUT's instructions for more information). If the M-IN/OUT Expander is programmed as an Input and Output Expander, it must be enrolled as an Input Expander and as an Output Expander. For example, if you have programmed an M-IN/OUT Expander as an Input Expander and Output Expander, and assigned it address no. 1, you must enroll Input Expander no. 1 and Output Expander no. 1.



Low Battery Delay Set the delay for the low battery on the Power Supply Station (battery voltage below 11.4 V) before it will be signalled.





Valid entries: 0 through 3600 seconds, in 1 second step.

Default setting: 0 seconds

 *In order to comply with the EN50131-6 standards, this option MUST NOT be more than 300 seconds.*

The Control Panel can detect and signal:

- forced opening or removal of Power stations;
 - interruption of power supply to the Power stations;
 - the status of Power station batteries;
 - the status of Power supply modules;
 - the status of Power station Outputs.
- Forced opening or removal will be signalled by:
- the **Tamper on BPI Device** event (refer to “Events-Actions” section);
 - an **X** above the  icon on the Keypad;
 - the Event details in the log
- DESCRIPTION** — Tamper on BPI device
WHERE — The Power Station label
- Mains power failure (interruption) will be signalled by:
- the **Warning mains failure on Power station** event (refer to “Events-Actions” section);
 - the ON status of the  LED on the keypads, and the **AC Mains Failure** message (refer “View Trouble Mode” in the USER MANUAL);
 - the Event details in the log
- DESCRIPTION** — AC Mains Failure
WHERE — The Power Station label
- Low Battery (below 11.4 V — refer to “Static Test” under “Connecting Power supplies” in the “INSTALLATION” section) will be signalled by:
- the **Warning low battery on Power station** event (refer to “Events-Actions” section);
 - the ON status of the  LED on the keypads, and the **Low Battery** message (refer “View Trouble Mode” in the USER MANUAL);
 - the Event details in the log
- DESCRIPTION** — Low Battery
WHERE — The Power Station label

- Battery Trouble (refer to “Dynamic Test” under “Connecting Power supplies” in the “INSTALLATION” section) will be signalled by:
- the **Warning power trouble on Power station** event (refer to “Events-Actions” section);
 - the ON status of the  LED on the keypads, and the **Troub. pow. syst.** message (refer “View Trouble Mode” in the USER MANUAL);
 - the Event details in the log
- DESCRIPTION** — Troub. pow. syst.
WHERE — The Power Station label
- Disconnected Battery² will be signalled by:
- the **Battery not connected on Power station** event (refer to “Events-Actions” section);
 - the ON status of the  LED on the keypads, and the **Batt. disc. pw.s** message (refer “View Trouble Mode” in the USER MANUAL);
 - the Event details in the log
- DESCRIPTION** — Batt. disc. pw.s
WHERE — The Power Station label
- Power supply module trouble³ will be signalled by:
- the **Battery charger trouble on Power station** event (refer to “Events-Actions” section);
 - the ON status of the  LED on the keypads, and the **Fault chrg.pw.s** message (refer “View Trouble Mode” in the USER MANUAL);
 - the Event details in the Log
- DESCRIPTION** — Fault chrg.pw.s
WHERE — The Power Station label
- Disconnected Power supply module⁴ will be signalled by:
- the **Switching not connected on Power station** event (refer to “Events-Actions” section)
 - the ON status of the  LED on the keypads, and the **Swch.disc.pw.s** message (refer “View Trouble Mode” in the USER MANUAL)
 - the Event details in the log
- DESCRIPTION** — Swch.disc.pw.s
WHERE — The Power Station label
- Current draw of a Power station output that exceeds the maximum will be signalled by:
- the **Short circuit output 1/2/3 on Power Station** event (refer to “Events-Actions” section)
 - the ON status of the  LED on the keypads, and the **Out. short pw.s** message (refer “View Trouble Mode” in the USER MANUAL)
 - the Event details in the log
- DESCRIPTION** — Out. short pw. s
WHERE — The Power Station label

2 If the battery voltage drops below 10.2V, the Power station will disconnect it automatically. This operation will prevent damage to the battery.

3 The Power supply module of the Power station will be considered “out-of-order” if its output voltage reaches 0.5V above, or drops to 0.5 V below the preset value. If the Power station is not equipped with a Thermal probe, the output voltage will be 13.8 V. If the Power station is equipped with a Thermal probe, the output voltage will depend on the probe temperature.

4 The Power station will disconnect the Power supply module if its output voltage reaches 0.5V above the preset value. This operation will prevent damage to the peripherals. The power to the peripherals will be provided by the Power station battery. If the Power station is not equipped with a Thermal probe, the preset output voltage will be 13.8 V. If the Power station is equipped with a Thermal probe, the output voltage will depend on the probe temperature.

■ Wireless Module

The Wireless Module page will allow you to enroll and set up the Receiver connected to the KEY BUS.

 For information regarding the **Enabled** option, refer to “Configuration”.

The Control Panel signals the **lost** of the Receiver by:

- the ON status of the ▲ LED on the keypads in *standby status*;
- the message **WLS rec. lost** on the LCD keypads in *Tamper Alarm Visualization* mode (LED ▲ ON);
- the **WLS receiver lost** event.

The Control Panel signals the receiver **opening** and **wall detaching** by:

- the ON status of the ▲ LED on the keypads in *standby status*;
- the message **WLS receiver** on the LCD keypads in *Tamper Alarm Visualization* mode (LED ▲ ON);
- the ✕ character next the 📡 icon on the LCD keypads in *Partition Status* mode;
- the **Wireless Receiver Tamper** event.

Supervision Period This option will allow you to program the supervisory time for the Supervised Wireless Zones (refer to “Supervision” under “Zones”). Each wireless zone should send a supervisory signal within a programmed interval. If the Receiver does not receive the signal it will generate a **Loss of Wireless Zone** event.

Valid entries: 1-96 1= 15 minutes; 4= 1 hour; 96= 24 hours (in 15-minute steps).

At default: 15 minutes

 In order to comply with the EN50131-5-3 standard, the **Supervision Period** must be 15 minutes.

Jamming Detect If ENABLED, **BOSS** reserves the last Wireless Detector slot (the n. 32) to the RF jamming detection and signalling, and assigns it to the last Software Zone, with 200000 ESN.

If the Control Panel detects RF jamming, it will be signalled: by an ✕ above the 📡 icon on the Keypad, and by the **Tamper wireless device** event.

 *Jamming and BPI Device Tamper will be signalled by ✕ above the 📡 icon on the Keypad. Jamming and Receiver Tamper will be signalled by the **Tamper wireless device** event. If the signal is due to Receiver Tamper (jamming, opening or removal) the **WLS Tamper** event will be logged.*

Zones

The **Zones** Option Groups will allow you to set up the Zone options, as described below: the first column shows the (Software) Zones supported by the selected Control Panel.

Label This 16 character option will allow you to assign and/or edit the Zone label. The label will identify the Zone in all parts of the Application.

Position This option allow you to select the terminal (Physical Zone) to assign to the selected (Logical) Zone:

- Select the terminal’s device (Main Board, Wireless, Expander IN);
- Select the terminal (T1, T2, etc, for Hardwired Zones, Slot 1, Slot 2, etc, for Wireless Zones).

 *Assigning Physical Zones to Logical Zone is done automatically every time you run the Wizard setup (see “Zone Automapping” in the “APPENDIX” section).*

 *You can’t set **Wireless Zone** for Command Zones.*

Balance The Balance Type determines the electrical state (on the Zone input terminal) that will trigger Alarms.

 *In order to comply with the EN50131-1 and EN50131-3 standards, the Command Zones’s **Balance** must be **Double End Of Line**: the **Single End Of Line Balance** is not protected against cutting when the panel is disarmed.*

 *In order to comply with the EN50131-1 and EN50131-3 standards, Zone Alarm’s **Balance** CAN’T be **Normally Closed** and **Normally Open**, because the line is not protected against short circuit and cutting.*

 *The following electrical states must be present on the Zone Input terminals for at least 0.3 seconds.*

Normally Open — The zone is in Standby status when the zone terminal is open. The zone is in Alarm status when the zone terminal is connected to negative. (e.g. Fire detectors).

Normally Closed — The zone is in Standby status when the zone terminal is connected to negative. The zone is in Alarm status when the zone terminal is open.

Single End Of Line — The Zone is in Standby status when a 10 Kohms resistor (brown-black-orange-gold) is connected between the zone terminal and negative. If the terminal zone shorts to negative, the Control Panel will detect Tamper conditions and generate the following events:

- **Tamper on zone** (relative to the zone concerned);
- **Tamper alarm on partition** relevant to the Partition the Zone is assigned to.

In all other cases (Unbalancing, Open, etc.) the zone is in Alarm status.

❑ **Double End Of Line** — The Zone in standby status when two 10 Kohms resistors (brown-black-orange-gold) are connected in parallel between the zone terminal and negative.

If one of the resistors disconnects, the Control Panel will generate the events associated with the Zone Type (refer to “Type”). In all other cases (Zone Open, Connected to Negative, etc.), the Control Panel will detect Tamper conditions and generate the following events:

- **Tamper on zone** (relative to the zone concerned);
- **Tamper alarm on partition** relevant to the Partition the Zone is assigned to.

This Balance Type (using 2 wires) will allow the system to detect open **Alarm** and **Tamper** contacts (refer to “Connecting to a Double Balance zone”).

Wireless Device Serial Number This option is for the ESN (Electronic Serial Number) of the Wireless detector which is assigned to the selected Zone.

👉 *You cannot program the device parameters until you have entered its ESN.*

The ESN will allow the Control Panel to identify the wireless device on the system.

👉 *Some Wireless Devices have 5-digit and 6-digit ESNs (printed on back), use ONLY 6-digit ESNs with this Control Panel.*

❑ **Replacing Wireless Detector** — To replace a Wireless detector (assigned to a Zone): select the required Zone, then enter the ESN of the new Wireless detector in the **Wireless Device Serial Number** option.

❑ **Enrolling Wireless Detector** — To enrol a Wireless detector: select an empty Zone, then enter the Wireless detector ESN in the **Wireless Device Serial Number** option.

❑ **Unenrolling Wireless Detector** — To unenrol a Wireless detector (assigned to a Zone): select the required Zone then enter 000000 in the **Wireless Device Serial Number** option.

Wireless-Supervision If this option is Enabled, the system will be able to signal the loss of the Wireless detector. The Receiver will trigger the **Lost wireless zone** event as soon as the programmed Supervisory time expires (refer to the **Time supervision zones** under “Accessories” in the “Configuration” section). The placement of Wireless detector will not be indicated, however, the respective information will be recorded in the log.

Type The **Type** determines the affect the Armed/Disarmed status of the partitions will have on the Alarm signals, and whether the Zone will trigger Alarms immediately or after a programmed delay.

👉 *All Zones — other than **Fire** and **24h** — will be classified as **Burglar**.*

❑ **Instant** — Violation (refer to “Balance” and “Sensitivity”) of an Instant Zone — that is not Unbypassed or in Test status (refer to “Attributes”); has not run its programmed Cycles (refer to “Cycles”), and whose Partitions are Armed — will generate the following events:

- **Alarm on zone** (related to the Zone concerned);
- Generic alarm on partition** — relative to the Armed Partitions of the Zone.

❑ **Entry delay** — Violation of an **Entry Delay** Zone — that is not Unbypassed or in Test status; has not run its programmed Cycles, and whose Partitions are Armed — will trigger the longest **Entry Delay** of all of its Partitions. All the associated Keypads will beep until the delay expires. If the Partitions the Zone is assigned to are not Disarmed before the delay expires, or if the Zone is violated after the Delay, the system will generate the Events like an **Instant** Zone.

The first Zone on the path to a Disarm point (Reader or Keypad) should be programmed as an **Entry delay** Zone.

❑ **Entry path** — Violation of an **Entry path** Zone will generate the events like an **Instant** Zone, unless during the **Entry Time** of its Partition (and also unless the zone is bypassed or in Test status or has run its programmed Cycles).

Violation of an **Entry path** Zone — during the **Entry Time** of its Partition — will not trigger any events.

The Zones leading to a Disarm point (Reader or Keypad) should be programmed as **Entry path** Zones.

❑ **Exit delay** — Violation of an **Exit delay** Zone — during the **Exit Time** of its Partition — will not trigger any events. In all other cases, the system will generate the Events like an **Instant** Zone (unless the zone is bypassed or in Test status or has run its programmed Cycles).

The Zones leading out of a Partition should be programmed as **Exit delay** Zones.

❑ **Last exit** — Violation of a **Last Exit** Zone — during the **Exit Time** of its Partition — will not generate any Events but will replace any residual **Exit Time**, and trigger the programmed **Last Exit Time** of its Partition.

In all other cases, the system will generate the Events like an **Instant** Zone (unless the zone is bypassed or in Test status or has run its programmed Cycles).

This feature will allow the system to Arm as soon as the programmed **Last Exit Time** expires.

The last Zone leading out of a Partition should be programmed as a **Last Exit** Zone.

❑ **24 hr** — Violation of a **24h** Zone — regardless of the status of its Partition — will generate the Events like an **Instant** Zone (unless the zone is bypassed or in Test status or has run its programmed Cycles).

24hr Zones can be used for control applications, such as switching on courtesy lights (using infrared sensors).

- ❑ **Fire** — This type of zone is automatically programmed as a **24h, N.O.** (Normally Open) zone. Violation of a **Fire** Zone — regardless of the status of its Partition — will generate the following events:
 - **Alarm on zone** (relevant to the Zone concerned);
 - **Generic alarm on partition** — relevant to the Partition the Zone is assigned to.
- ❑ **Hold-up** — Violation of an **Hold-up** Zone — regardless of the status of its Partition — will generate Events like an **Instant** Zone (unless the zone is bypassed or in Test status or has run its programmed Cycles). Moreover:
 - events generated by the **Hold-up** zone CANNOT activate output n. 1;
 - the Keypad WILL NOT signal Alarms triggered by **Hold-up** Zones (the ▲ indicator WILL NOT blink);
 - the Keypad WILL NOT signal outgoing calls triggered by **Hold-up** Zones by mean of the event **Alarm on zone** (WILL NOT appear above the 🔔 icon).

🔊 *If a Hold-up zone is active, the EN50131 and EN50131-3-1 standards require that the arming can't be performed. Forced arming is still possible from the LCD keypad.*

👉 *If the **Zone Fault** option is also enabled, the violation of a **Hold-Up** Zone ONLY generates the **Zone Detector Fault** event.*

🔊 *In order to comply with the EN50131-1 and EN50131-3 standards, if your system has a **Hold-Up** Zone, at least one "Hold-up device fault" Zone must be present too: **Hold-up** and **Zone Fault** options enabled.
Default: zone n. 6 (Terminal **L2** of the **Panel**).*

- ❑ **Zone Fault** — Violation of an **Zone Fault** Zone — regardless of the status of its Partition — will generate the **Zone Detector Fault** event.
Default: zone n. 5 (Terminal **L1** of the **Panel**) and n. 6 (Terminal **L2** of the **Panel**).

👉 *The **Zone Fault** Zone supports the **Single End of Line Balance** ONLY.*

🔊 *In order to comply with the EN50131-1 and EN50131-3 standards, in the system must be at least one **Zone Fault** Zone.*

- ❑ **Internal Siren Fault** — Violation of an **Internal Siren Fault** Zone — regardless of the status of its Partition — will generate the **Fault on Internal Siren** event.
Default: zone n. 7 (Terminal **L3** of the **Panel**).

👉 *The **Fault on Internal Siren** Zone supports the **Single End of Line Balance** ONLY.*

🔊 *In order to comply with the EN50131-1 and EN50131-3 standards, in the system must be at least one **Internal Siren Fault** Zone.*

- ❑ **External Siren Fault** — Violation of an **External Siren Fault** Zone — regardless of the status of its Partition — will generate the **Fault on External Siren** event.
Default: zone n. 8 (Terminal **L4** of the **Panel**).

👉 *The **External Siren Fault** Zone supports the **Single End of Line Balance** ONLY.*

🔊 *In order to comply with the EN50131-1 and EN50131-3 standards, in the system must be at least one **External Siren Fault** Zone.*

Roller Blind-Enabled This option must be enabled on the Zones used for Roller blind contacts (This is valid only for main board zones). If you enable this option you must set the **Roller Blind-Window** and **Pulses-Number**, that determine the zone violation.

Roller Blind-Window Set the time available to count the set **Pulses-Number** so the zone will trigger an alarm), as per the following example.
E.g. a zone with a **Pulses-Number** of 4 and a **Roller Blind-Window** of 2 minutes, will signal violation when its contact generates 4 pulses within 2 minutes.

Vibration-Enabled This option must be enabled on the Zones used for Vibration detectors (This is valid only for main board zones). If you enable this option you must set the options **Vibration-Sensitivity** and **Pulses-Number**, that determine the zone violation, as per the following example.

Vibration-Sensitivity If the **Pulses-Number** is 0 or 1, the zone alarm is triggered with a single pulse with a duration equal to that of the **Vibration-Sensitivity**: from 1, very sensitive, to 20, insensitive.

If the **Pulses-Number** exceeds 1, the zone alarm is triggered ALSO when the **Pulses-Number** set is counted: the pulses must be at least 250 µs long.
E.g. a zone with the **Vibration-Sensitivity** of 10 and **Pulses-Number** of 5 will generate an alarm when:

- it detects a single pulse that exceeds the **Vibration-Sensitivity** of 10 (the zone will be open for at least 50 ms);
- it detects 5 pulses at least 250 µs long.

Cycles This option determines the number of times the Zone will be able to trigger the Zone Alarm event.
Valid entries: 0 through 255:

- If 0 is set up, the Zone will be unable to trigger Zone Alarm events;
- if any number **other than 0** is set up, the Zone will be able to trigger the corresponding number of Alarm events;
- if **255** is set up, the Zone will be able to trigger an unlimited number of Zone Alarm events.

The Zone Alarm Cycle counter will reset when:

- one of the Partitions of the Zone changes status;
- one of the Partitions of the Zone Resets;
- one of the Partitions of the Zone exits Block Alarm status;
- the programming session ends (i.e. when you exit the Installer Menu or complete downloading via the PC);
- the Zone is Unbypassed.

 A Zone that signals a persistent Alarm condition (e.g. due to Trouble conditions) will generate one Alarm cycle ONLY. It will be unable to generate further cycles until the Alarm counter has been cleared.

 In order to comply with the EN50131-1 and EN50131-3 standards, the Hold-up Zone's Cycles must be 255.

Pulses-Number Set the number of pulses required (the number of times the zone is violated) before the zone generate an alarm. Depending on the zone type it has different meanings and value ranges.

- For zone with **Roller Blind** option **Enabled** it determines the number of fast pulses (greater than 600 µs) the zone will allow before signalling the alarm (1 through 7).
- For zone with **Vibration** option **Enabled** it determines whether the zone alarm is triggered by a pulse with a length equal to the **Vibration-Sensitivity** set (0 or 1) or ALSO when the **Pulses-Number** set is counted.
- For all **other type of zone** it determines the number of pulses required (pulses greater than 300 ms) before the zone trigger an alarm (value range 1 through 3).

Pulses-Window Set the time to count the **Pulses-Number** programmed.

Valid values: Disabled, and from 4 to 64 s in steps of 4 s.

Default: 4 seconds.

Alarm if single pulse longer than time window If this option is disabled (default), the zone goes into alarm when it counts the programmed **Pulses** before the programmed **Window** expires.

If this option is enabled, the zone goes into alarm even when it detect a single pulse longer than the programmed **Window**.

Attributes-Bypassable Zones with this attribute can be Bypassed.

 In compliance with the EN50131-1 and EN50131-3 standards, a bypassed zone is defined **Isolated Zone**, when it is manually bypassed by the user; **Inhibited Zone**, when it is automatically bypassed by the panel (see "Autobypassable" and "Autobypass with Reset Unbypass").

Attributes-Chime Violation of a Zone with this attribute — during Disarmed status of its Partition — will generate the **Chime on partition no.** event, and an audible signal (beep) on the assigned Keypads and PROXI readers. Violation of a **Chime** Zone — during Armed status of its Partition — will trigger the Actions programmed for the **Type** parameter.

 The **Chime** Attribute is ineffective on **24h** and **Fire** Zones.

Attributes-Test Violation of a Zone with this attribute WILL NOT generate the **Alarm on zone** event. However, the "Alarm - Zone under test" message will be recorded in the Control Panel log. The **Test** phase will allow you to check the functionality of the Zones without triggering Alarm signals. At default, the Control Panel will record ONLY the Events that occur during Armed status.

 In order to comply with the EN50131-1 and EN50131-3 standards, the tamper continues to work properly, during the test: information on the keypads, event logger, outputs and telephone actions.

Attributes-Internal Zones with this attribute will be bypassed when their Partitions Arm in Stay mode or Stay with Zero Delay mode.

Attributes-OR Violation of a Zone with this attribute can generate the Events according to the assigned Type, even when only ONE of its Partitions is Armed.

Attributes-Autobypassable Zones with this attribute will be bypassed automatically, if violated during Arming procedure of their Partitions. They will be unbypassed when their Partitions are Disarmed.

 The **Autobypassable** attribute is ineffective on **Exit Delay** Zones.

Attributes-Autobypass with Reset Zones with this attribute will be bypassed automatically, if violation occurs during Arming procedure of their Partitions. They will be unbypassed when standby is restored.

Behaviour-Mode The Zones can be used for system monitoring (Alarm Zones), or management (Command Zones).

 The **Wireless** Zones CANNOT be Command Zones.

Alarm Event — If Alarm conditions are detected, the Alarm Zones will generate the respective event (refer to "Type"). The **Events-Action** page will allow you to associate each event with one or more actions (activation of Outputs, Digital Communicator, Dialler, etc.). The system cannot generate an Alarm event until the Partitions the Zone is assigned to Arm (refer to "Partitions").

 This does not apply to **24h** and **Fire Zone** events, as these events do not depend on Partition status.

If the zone is NOT an **Exit Delay** or **Last Exit Zone** (refer to "Type") the Control Panel will start monitoring as soon as the Partitions the Zone is assigned to Arm, otherwise, it will start monitoring when the longest **Exit Delay** of the Armed Partitions the Zone is assigned to ends (refer to "Partitions").

Each Alarm Zone can generate the Zone Alarm event for the programmed number of times (refer to "Cycles").

Command — Each Command Zone can be programmed to activate one of the following actions:

- Arm Only
- Disarming
- (Bistable) Arm/Disarm
- Clear Call Queue
- Alarm Reset

The Command Zones will activate when they are unbalanced (refer to "Balance") for the programmed number of times or length of time (refer to "Sensitivity").

Behaviour-Command Type If a **Command** Zone triggers an Alarm (see "Balance" and "Sensitivity"), the system will generate the programmed Actions. In all other cases (Tamper and Short Circuit) it will operate as an Alarm Zone.

Command Zones will be active at all times, regardless of the status of their Partitions (Armed/Disarmed).

Arm Only — If this command is selected, all the Partitions the Zone is assigned to will Arm when the Zone triggers an Alarm.

Disarming — If this command is selected, all the Partitions the Zone is assigned to will Disarm when the Zone triggers an Alarm.

Arm/Disarm — If this command is selected, all the Partitions the Zone is assigned to will Arm — when the Zone triggers an Alarm, and Disarm — when it restores to standby.

 *Partitions — Armed by an **Arm Disarm** Command Zone — cannot be Disarmed until all the Zones of that type are in standby status (and CANNOT be Disarmed via Keypad, Reader, Telephone or PC).*

Behaviour-Clear Call Queue — If this option is enabled, the Call Queue will be cleared when the Zone triggers an Alarm for all the event associated to the partition assigned to the zone. If the zone is Enabled over all area, when the zone is violated, also the system call(s) will be cleared.

Behaviour-Alarm Reset — If this option is enabled, all the Partitions the Zone is assigned to will Reset when the Zone triggers an Alarm.

Options-In And Group If this option is enabled, the Partition the zone is assigned to goes in alarm when another Partition Zone with this option enabled goes in alarm before a 30 minute window expires.

Any time the Partition is armed the AND zone timer is reset to zero.

If any zone with this option enabled, is violated while the timer is NOT running:

- the timer starts with a fixed value of 30 minutes;
- the Partition alarm is NOT generated;
- the zone alarm is NOT logged;
- the zone which started the timer is stored.

If the same zone is violated again while the timer is running:

- the zone alarm is NOT logged;
- the timer is restarted.

If another Partition Zone with this option enabled, is violated while the timer is running:

- the zone alarm is logged;
- the Partition alarm is generated;
- the timer restarts again.

If the timer expires:

- the timer expired event is logged.

Options-Real Time If this option is disabled (default), the zone alarm event ends when the system alarm time expires.

If this option is enabled, the zone alarm event ends when the zone goes back to standby status.

Options-Active On Keypads If this option is enabled, the zone activation generates a message on the keypads associated to the partitions the zone is assigned to.

 *The message is displayed ONLY on keypads with option **EN50131** disabled.*

Options-Check Inactivity If this option is enabled, the Control Panel check the inactivity on the Zone.

 *Refer to the **Delinquency** option on the **Partition Group** for more information.*

Partitions This option will allow you to assign the Alarm and Command Zones to the Partitions.

➤ **For Alarm Zones**, will determine which User PINs, Keys and Operating Times will be associated with the Zone. Each Alarm Zone can be assigned to more than one Partition.

 *If the Zone is a Delayed Zone (Entry Delay, Path, Exit Delay or Last Exit Delay), the system will apply the longest Entry Delay, Exit Delay or Last Exit Delay of all its Armed Partitions.*

➤ **For Command Zones**, will determine which Partitions the Zone will be able to control. Each Command Zone can operate on more than one Partition.

Partitions

Each Partition consists of a group of zones that the Control Panel manages independently (Virtual Control Panel). Each Partition can be programmed with its own Codes, Timers, Actions and Parameters.

This Control Panel manages 16 Partitions. You can setup the Partitions in the **Zones** group.

The **Partitions** group allows you to set up the options for the zones, as described below.

The first column shows the Partition Identification Number.

Label This option is for the Partition Label (16 characters). The Partition **Label** will identify the Partition in all the operations it is involved in.

SMS Label Enter a code to identify the Partition in the operations via SMS (see "USER MNUAL > SMS OPERATIONS").

Valid values: up to 5 characters.

Default: the identification number of the Area.

Time-Entry Delay Any partition can have an **Entry Delay**, during which the **Entry Path** and the **Entry Delay** zones are not able to alarm the partition. This time starts when the partition is armed in Stay or Away mode, and an **Entry Delay** zone is violated.

The Partition **Entry Delay** will be signalled by:

- the **Entry Delay on partition** event for the Partition;
- an audible signal from the Partition Keypads.

The duration of the timer should be programmed to have enough time to reach the point in which the partition can be disarmed.

- The valid range is 15 to 3600 seconds
- The default setting is 30 seconds.

Time-Exit Delay Any partition can have an **Exit Delay**, during which the **Exit Delay** zones are not able to alarm the system. This time starts when the partition is armed in Stay or Away mode. At the end of the **Exit Delay** the **Exit Delay** zones becomes Instant zones.

The Partition **Exit Delay** will be signalled by:

- the **Exit Delay on partition** event for the respective Partition;
- an audible signal on the Partition Keypads;
- The valid range is 15 to 3600 seconds;
- The default setting is 30 seconds.

Time-Last Exit Time Violation of an Armed **Last Exit** Zone will trigger the programmed **Last Exit Time** of its Partition. This feature will allow the system to Arm as soon as the programmed **Last Exit Time** expires.

- Valid entries: 5 through 3600 s, in 1-s steps.
- If you enter a higher value, it will be converted automatically to the maximum admissible value.
- Default setting: 15 seconds.

Time-Negligence Under normal circumstances, Users Arm their systems with a certain regularity, if this does not occur, it may be due to Negligence on the User's behalf or may mean that the User is in difficulty (due to serious illness, accident or delinquency), in which case, this feature will prompt the Central station operator to take the necessary action.

This option will allow you to set the **Negligence Time**. If the system is not Armed within the programmed time, the Control Panel will generate the **Negligence on Partition** event.

- Valid entries: 0 through 40 days in 1-day steps.
- If this option is left at default (0), Negligence will not be signalled.

Negligence will be signalled by:

- the **Event negligence on partition** event — relevant to the Partitions the Zone is assigned to.

Time-Inactivity This option allows the system to monitor Alarm Zone inactivity (non-detection of motion), when the Partition is Disarmed. The **Inactivity** function provides protection against the detector blinding and allows the system to detect zone malfunction. Under normal circumstances, users disarm the system when they are on the premises, therefore, the zones should detect motion (violation) quite frequently. If this does not occur, the system will suppose that the user is unable to move (due to serious illness, accident or delinquency) and as a result will generate a **Delinquency on Partition** event, thus prompting the Central station operator to take the necessary action.

- Valid entries are 0 through 240 hours (10 days) 1-hour steps.
- Zero means that Zone Inactivity will not be signalled.
- The default setting is Zero.

Zone Inactivity will be signalled by:

- the event **Delinquency on partition** — relating to the Partitions the Zone is assigned to.

 The ▲ LED (ON) signals several different types of Trouble events. If the signal is due to Inactivity, the Keypad (in View Trouble Mode) will show the Inactivity message (refer to "View Trouble Mode" in the USER'S MANUAL).

The following information will be recorded in the Event log:

- TYPE: Inactivity
- ID. EVENT: Description of the Partitions the Zone is assigned to;
- AGENT: None;
- ID. AGENT: Description of the Zone that triggered the Inactivity event.

Zone Inactivity will end when:

- the Zone restores standby;
- the Zone triggers an Alarm;
- ALL the Partitions the Zone belongs to Disarm.

The end of a Zone Inactivity event will be signalled on the ▲ LED (OFF) on Keypads which are enabled on at least one of the Partitions the Zone belongs to.

 The ▲ LED switch OFF **ONLY** when there are no Inactive Zone or Trouble signals relating to the Keypad Partitions.
As the event is a Spot event, the termination of a Zone Inactivity event will not be signalled.

Time-Patrol This option will allow you to set the **Patrol Time**. If the partition is disarmed by a User Code or a key with the Patrol attribute (refer to "PIN and Key"), it will rearm automatically when the programmed **Patrol Time** expires.

Valid entries: 0 through 254 minutes in 1-minute steps.
Default setting: 10 minutes.

And Keys Code-Time After arming a partition, the **AND Codes Timeout** is not running. After entering an AND code or inserting an AND key while the timeout is not running the **AND Codes Timeout** starts. Before this timeout expires, the number of keys and/or codes set in the option **And Keys Codes Num** must be entered/inserted, and then the last AND code or key used is allowed to disarm the partition itself. If the timeout expires without the complete codes/keys group is used an event is stored in the system logger. The timeout is enabled to restart any time the partition is re-armed or after it expires.

And Keys Codes-Num Set the number of And Keys/Codes required to disarm the partitions. You can set Disabled, (an Key/Code ONLY is necessary) 2 or 3.
If you set 0 the option is disabled: you need to use only one key/code to disarm the partitions even if you have set And Keys/Codes.

Timer-Arm This option provides the system with an *Arm command filter*. If a Timer window is associated with a Partition, the system will carry out commands to Arm the Partition concerned **ONLY** when the respective Timer window is running (refer to "Scheduler - Timers").

Timer-Disarm This option provides the system with a *Disarm command filter*. If a Timer window is associated with a Partition, the system will carry out commands to Disarm the Partition concerned **ONLY** when the respective Timer window is running (refer to "Scheduler - Timers").

Max. Overtime Requests This option will allow you to set the maximum number of Overtime Requests.
EXAMPLE: If a Timer controlled Partition is scheduled to Arm at 17:45 — and the Overtime request period is set at 60 minutes, and the Max. No. of Overtime requests is set at 2 — Arming can be postponed until 19:45 by two Overtime requests (17:45 + 2 x 60 minutes), after which, Overtime requests will be ignored. The maximum Overtime request is 180 minutes.

 *Overtime Requests will affect the imminent Arming event ONLY.*

Phonebook

The **Phonebook** option group is a list of telephone numbers that may be used by the Control Panel to carry out voice or digital calls, on the PSTN channel or GSM channel.

 *The Telephone Numbers used for Arming/Disarming the Partitions via SMS must be present in the Phonebook, otherwise the Control Panel rejects the call.*

Label This option is to enter a significant label for the number.Phone Number.

Enabled You can enable/disable the communication on the Telephone Number.
You may need to disable the Telephone Number without cancel all its settings, to re-enable it after a certain period.

White list If the **Black List** option is ENABLED (see **GSM** options group), the control panel **ONLY** answers calls coming from telephone numbers with the **White List** option enabled.
Default: disabled.

 *This option ONLY affects calls received on the GSM channel. The control panel always answers calls received on the PSTN channel.*

Caller ID over GSM If ENABLED, the telephone number can activate the respective **Caller ID to Tel.** event (see "Events and Actions>Events Controlled by Caller ID").
Default: disabled.

 *The event is activated at "zero cost" as once the caller is recognised, the Control Panel activates the event without answering the call.*

Number This option is to enter the phone number that will be called: you can enter up to 16 characters.
Valid entries: digits from 0 to 9, digit - (dash) for a **2 seconds pause**, and digit _ (underscore) for **4 seconds pause**.
The 2 seconds pause can be inserted, for example, between a switchboard number and a telephone number.

 *The Telephone Number may be entered with or without the international prefix, as required; the international prefix must be entered using the 00xx format; the application does NOT accept the +xx format.*

Type This option is to set up the phone number for Voice Dialler or Digital Dialler:
➤ the **Voice Dialler** will send a Voice Message to the relevant Phone Number;
➤ the **Digital Dialler** will send digital information to the relevant Phone Number.

Digital Protocol This option will allow you to set up the Reporting format used by the Control Panel to send digital information to the Phone number.

This Control Panel supports **Contact ID** and **SIA** Reporting formats.

Once the digital transmission has been completed, the Control Panel, if the relative option is enabled (see **Audio Session** options), will open an audio channel that let to the Central Station operator to verify the alarm communication.

The system users will be able to communicate with the Central Station operator via the **AS100** Audio Station. The voice channel will remain open until the Central Station operator ends the session.

 *The Central Station must be able to manage audio communications.*

Account This option is for the System Account Code (usually assigned by the Central Station). The Account Code format (number of digits and valid entries) depends on the selected Reporting Format (refer to the **ACCOUNT CODE** column in the Table 8).

■ **Audio Session**

Disabled This option is to disable the phone number for the remote actions from telephone.

Two Way Call If you enable this option the Control Panel opens a two way audio session once the transmission has been completed. In this way the Central Station operator will be able to speak with the person that need help, by means the **AS100**'s microphone and speaker.

 *Adjust the **Speaker Volume** and **Microphone Volume** on the GSM module (see the **GSM** option group) to resolve any problems starting the two-way communication session via the GSM.*

Audio Verification If this option is enabled, the Control Panel opens an Audio channel, once the transmission has been completed. In this way the Central Station operator will be able to verify the event by means the **AS100**'s microphone.

 *The Central Station must be able to manage audio communications, otherwise, the **Listening** option cannot be enabled.*

The Audio channel will remain open until the Central Station operator ends the session.

 *The Control Panel transmits **ONLY** one event per call when the **Listening** option is enabled.*

One Way +Audio Verification If you enable this option the Control Panel opens a **10 seconds** one way talking session once the transmission has been completed. In this way the Central Station operator will be able to inform the persons that their conversations will be listen, by means the **AS100**'s microphone and speaker.

DTMF Menu If this option is enabled, when the Control Panel call the number, supports the User's navigation trough vocal functions with the following messages:

- n.163 (Menu 1): Press one for vocal functions.
- n.173 (Sub Menu 1/1): Press one to switch between talking and audio verification.
- n.174 (Sub Menu1/2): Press two for two-way call.
- n.175 (Sub Menu1/4): Press four to reduce audio verification sensitivity.
- n.176 (Sub Menu1/5): Press five for standard audio verification sensitivity.
- n.177 (Sub Menu1/6): Press six to increase audio verification sensitivity.

■ **Priority**

Choose the communication channel that the Control Panel should use to call the Phone Number and its priority.

- **Only PSTN:** the Control Panel will only use the PSTN channel.
- **Only GSM:** the Control Panel will only use the GSM channel.
- **PSTN Primary - GSM Backup:** the Control Panel will make a second attempt on the GSM channel if the first attempt on the PSTN channel fails.
- **GSM Primary - PSTN Backup:** the Control Panel will make a second attempt on the PSTN channel if the first attempt on the GSM channel fails.

 *This option refers to the outbound calls.*

 *If the GSM channel is used for communicating events with the Contact ID reporting format, adjust the **Speaker Volume** and **Microphone Volume** on the GSM module (see the **GSM** option group) to avoid any issues such as **Failed Communication on the Contact ID**.*

REPORTING FORMATS	TYPE	ACCOUNT CODE digits (valid entries)	REPORTING CODE digits (valid entries)	NOTES
CONTACT ID	DTMF	4 (0 ÷ F)	Refer to Event and Actions	0 = A
SIA	LAN	4 (0 ÷ 9)	Refer to Event and Actions	

Table 8 Digital Communicator Reporting Formats

Outputs

The **Outputs** Group Options will allow you to set up the Programmable Outputs options. The column on the left side of the **Outputs** page shows the Outputs supported by the selected Control Panel.

Label This option is to enter a significant name for the Output.

Enabled You can enable/disable the Outputs. You may need to disable the Output without cancel all its settings, to re-enable it after a certain period.

Position This option allow you to select the terminal (Physical Output) to assign to the selected Logical Output:

- select the terminal's device (Main Board or Expander Out);
- select the terminal (**Siren** refers to the terminals NC, COM, NO, +N e +A).

Type This option allow you to program the Output standby status.

- Normally Open** — In the standby status the Open Collector Outputs⁵ are open.
- Normally Closed** — The electrical state during standby is: Positive (13.8 V) on the [+N] terminal [+A] terminal open; [COM] terminal closed to terminal [NC]; [NO] terminal open; the Open Collector Outputs are closed to Negative.

☞ *The Relay Output can be programmed as Normally Closed ONLY.*

Reserved This option will allow the User to activate/deactivate the Output from the Keypad and via telephone (refer to "Outputs (ON/OFF)" under "OPERATING YOUR SYSTEM FROM A KEYPAD" section and "Turn Reserved Outputs ON/OFF" under "OPERATING THE SYSTEM FROM A TELEPHONE" section in the USER MANUAL).

☞ *The user may activate or deactivate ONLY the Reserved Outputs that share at least one Area with the PIN and the keypad used (the telephone is enabled over all Areas): see the **Partitions** option.*

☞ *The Master PIN can activate/deactivate the Output, via Status page, if the output is programmed as **Reserved**. If the output is not **Reserved**, only the Installer can activate/deactivate it.*

☞ ***Reserved** Outputs CANNOT be associated with the Events on the Events-Actions page.*

When you exit a programming session via PC, Modem or Keypad, the Reserved Outputs will restore to the status they were in before the programming session started.

⁵ The Open Collector Outputs are: the terminals O1 and O2 on the Main Board; the terminal T1, T2, T3 or T4 on the Main Board, when set as Output; the Terminal T1, T2, T3, T4, T5 or T6 on the Input/Output Expander, when set as output.

Monostable-Enabled If this option is disabled (at default) the Output is Bistable: it will activate when AT LEAST ONE of its associated Events occurs, and will stop when ALL of its associated Events end. If this option is enabled, the Output is Monostable: it will activate when AT LEAST ONE of its associated Events occurs, and will stop when the programmed **ON Time** expires (see "ON Time" below).

Monostable-Time ON This is the maximum activation time of the Output.

Valid entries: 1 through 25 seconds, in 1-second steps; 1 through 127 minutes, in 1-minute steps.

Default: 3 minutes.

Monostable-Time OFF This is the minimum OFF Time after restoral of the Output. The Output will be unable to re-activate until the programmed OFF Time expires.

Valid entries: 1 through 255 seconds, in 1-second steps;

Default: 6 seconds.

☞ *The **Monostable-Time On** and **Monostable-Time Off** can be set for Monostable Outputs ONLY.*

Timer This option will allow you to associate a Timer with the Output. The Output can be activated ONLY when the selected Timer is in the active state (refer to "Timer").

☞ *When the Timer window expires, the Output will restore to standby, even if the conditions that generated the event are still present.*

Cycles Setup the number of cycles the Output must run.

Valid entries: 1 to 31 or unlimited cycles.

Default: 1 cycle.

☞ *Outputs that have **Unlimited** set for the **Output** option come back to standby ONLY when you enter/exit to/from Installer Menu or download/upload the options, therefore this value should be set carefully.*

The Output will continue to run the programmed number of Cycles even after the triggering event has been cleared. During each cycle, the Output will be active for the programmed **ON Time** and will restore to standby for the programmed **OFF Time**. If an **Half Cycle** has been programmed, the Output will oscillate in accordance with the Half Cycle parameters (during the **ON Time**), as shown in Figure 24.

☞ *The **Cycles** option can be set for Monostable Outputs only.*

Half Cycle If this option is other than zero, the Output will remain active for the programmed time, return to standby for the same amount of time, and then reactivate, as shown in Figure 24. This option can be used to generate visual and audible signals (cause LEDs to blink or buzzers to sound).

Valid entries: 200 through 1400 milliseconds in 200 milliseconds steps.

If you set 0, the Output will not oscillate.

Partitions If disabled (default) the output is NOT assigned to the area.

If ENABLED, the output is assigned to the Partition:

- the output can be activated/deactivated from the keypad ONLY if the PIN and the keypad used share at least one Partition with those of the output;
- the output can be activated/deactivated by telephone ONLY if the PIN used shares at least one area with those of the output.

☞ These options are available ONLY for the **Reserved outputs**.



Figure 23 Arming by the Touch Keypad: labels 1, 2, 3 and 4 can be customised, as explained in the text; the corresponding Special arming initial letter will be put in position 5; the description assigned to the arming selected will appear in window 6, as explained in the text.

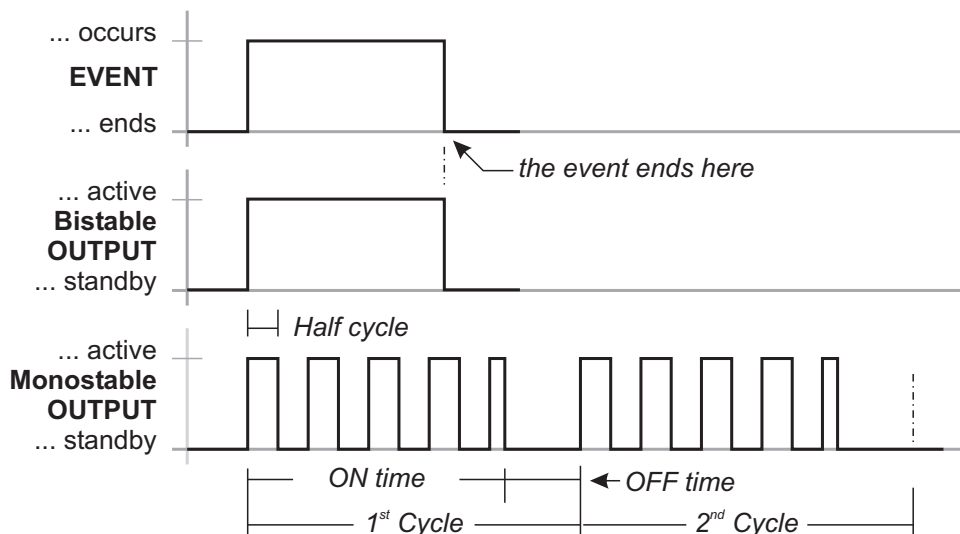

Figure 24 The Effect of the **Half cycle** and **Cycle** options on Bistable and Monostable Outputs

Voice Messages

This Option Group will allow you to manage voice messages. This Control Panel can store up to **206** messages of **20.7 minutes** in total: 1 12 s Long Message (High Quality); 205 6 s short messages (low quality). You can record the Voice Messages via a microphone connected to the PC or you can load a prerecorded messages from the PC resources (hard disk, LAN, etc.)

☞ This Control Panel supports WAVE audio files (.WAV), with different specifications. Possible conversion errors are handled: logged and displayed to the user.

🔴 **RECORD button:** press to start recording of the voice message.

📁 **LOAD button:** click to load a recorded voice message from the PC resources (hard disk, LAN, etc.).

💾 **SAVE button:** click to save the voice message on the PC resources (hard disk, LAN, etc.).

✕ **ERASE button:** click to delete the voice message.

▶ **PLAY button:** click to listen to the voice message.

⏸ **PAUSE button:** click to pause playing or recording of the voice message.

■ **STOP button:** click to stop playing or recording of the voice message.

When recording a message, a counter indicates (in real time) the time elapsed.

🔊 In order to comply with the EN50131-1 and EN50131-3 standards, reserved messages for alarm, tamper, fault and automatic arming refused (from No. 2 to No. 9 and No. 13) should NOT be modified. If there is a **Hold-Up Zone**, its message should NOT be changed (No. 14).

Options

The System Option Group is to setup the options that determine the operating mode of the system. You can find the following Sub-Groups System Group.

■ General

Lock Installer Code If this option is enabled, restoral of the default settings WILL NOT default the PIN of Installer Code.

 If the option **Lock Installer Code** is enabled, you CAN'T perform the Hardware Default. In this way ONLY the Installer (the person that know the Installer PIN) can perform the default restore via an LCD Keypad (refer to "Factory Default" in "KEYPAD OPERATION" section).

BOSS Access Code Enter the Installer PIN.
Default: 0104

 If the PIN entered in this option does not match with the one programmed into the Control Panel, you CAN'T download/upload the options.

User Code Length Enter the number of digits required for the PIN automatically generated by the control panel when the **Auto PIN Generation** option is enabled (refer to the relative option).

Valid entries: 4, 5 or 6. **Default:** 5.

 If the option **Auto PIN Generation** is disabled, the user can program an 4 to 6 digits PIN.

Auto PIN Generation If this option is enabled, the Control Panel generates a random PIN when the user asks for a new PIN. If this option is disable, the user can enter the required PIN when he asks for a new PIN.
Default: enabled.

 In order to comply with the EN50131-1 and EN50131-3 standards, this option should be ENABLED.

Clear System Calls by Master Code If disabled (default), the Main User PIN's can delete ONLY calls generated by Partition events from the telephone queue. If ENABLED, the Main User PIN's may ALSO delete calls generated by System Events from the telephone queue.

Clear Calls on Disarming by Master Code If ENABLED, disarming with a Main User PIN automatically cancels calls from the telephone queue.

 Depending on the status of the **Clear System Calls by Master Code** option, ONLY calls generated by Partiton Events and ALSO those generated by System Events will be deleted.

Default: disabled.

Enable Level 4 If this option is enabled, it is possible to access Level 4 from a keypad connected to the Control Panel (see "KEYPAD OPERATIONS").

Default: disabled.

Allow installer access to personal programming

Shows whether the installer is allowed to upload/download the user's PIN's onto/from BOSS and a USB key (read "OPERATING YOUR SYSTEM FROM A KEYPAD>Enable Installer (Teleservice) (2.2)" in the USER MANUAL).

 This is a read-only option.

T1 Input or Output Select the functioning mode for terminal **T1** on Main Board: **Input** or **Output**.

Default: Input.

T2 Input or Output Select the functioning mode for terminal **T2** on Main Board: **Input** or **Output**.

Default: Input.

T3 Input or Output Select the functioning mode for terminal **T3** on Main Board: **Input** or **Output**.

Default: Input.

T4 Input or Output Select the functioning mode for terminal **T4** on Main Board: **Input** or **Output**.

Default: Input.

A Arming Label Enter the message that the Keypads should show when Type **A** Arming takes place, as shown in Figure 23 (1) for the Touch keypad.

Valid entries: up to 16 characters.

Default: STAY type A.

B Arming Label Enter the message that the Keypads should show when Type **B** Arming takes place, as shown in Figure 23 (2) for the Touch keypad.

Valid entries: up to 16 characters.

Default: STAY type B.

C Arming Label Enter the message that the Keypads should show when Type **C** Arming takes place, as shown in Figure 23 (3) for the Touch keypad.

Valid entries: up to 16 characters.

Default: STAY type C.

D Arming Label Enter the message that the Keypads should show when Type **D** Arming takes place, as shown in Figure 23 (4) for the Touch keypad.

Valid entries: up to 16 characters.

Default: STAY type D.

LCD Keypad Standby Page Enter the message that the LCD Keypads should show in standby status.

Valid entries: up to 16 characters.

Default: BENTEL ABSOLUTA.

A Arming Description Insert a text that describes arming Type **A**: this text will be shown in the Touch Keypad when the corresponding arming is selected, as shown in Figure 23 (6).

Valid entries: up to 128 characters.

Default: empty.

B Arming Description Like “A Arming Description” but for arming type B.

Valid entries: up to 128 characters.

Default: empty.

C Arming Description Like “A Arming Description” but for arming type C.

Valid entries: up to 128 characters.

Default: empty.

D Arming Description Like “A Arming Description” but for arming type D.

Valid entries: up to 128 characters.

Default: empty.

Global Arming Description Like “A Arming Description” but for Global arming.

Valid entries: up to 128 characters.

Default: empty.

Squawk Time On Set the length of the squawk to signals an arming confirmation or inhibition condition: **one** squawk means confirmed arming, **two** squawks mean inhibited arming.

Squawk Time Off Set the pause between the two squawks of inhibited arming signalling.

Output for Squawk Select the Control panel output connected to the siren that will play the squawk.

Bypass Tamper on Zone If this option is enabled, bypassed Zones will not generate Tamper Alarms.

Enable Auto Arming If this option is enabled the Control Panel can perform the auto arming set in the **Event Schedule** option group.

Mains Fault Timeout This option will allow you to set the amount of time that must expire before the **Warning mains failure** event occurs.

Valid entries: 0 through 250 minutes, in 1-minute steps

Default: 0 minutes.

 *In order to comply with the EN50131-1, EN50131 and EN50131-3-6 standards, this option should not be more than 1 minute.*

Panel ID Code Enter the ID Code assigned to the control Panel during the Wizard Setup.

 *The Panel ID Code set in BOSS must match with the one set during the Wizard Setup of the Control Panel to Downloading/Uploading by means an USB key.*

Keypad Language Selection Select the language for the keypad messages.

Bell Cutoff Set the duration of the **Zone Alarm** event when the **Real Time** option is DISABLED (see Zones options). This option also determines the duration of partition Alarm.

Valid entries: 5 through 15.000 seconds in 1-second steps.

Default: 180 seconds (3 minutes).

 *Since an alarm is detected, before the end of this time, **it is no possible to activate again the siren.** The siren will be activated only for a new event will occur after this time.*

Country Selection for Tone Settings This is the same option as in the **Advanced Call** sub-group.

 *If your country is not in the list or if you have problems with the phone line, select **Custom** and set the parameters manually in the **Advanced Call** sub-group.*

Ignore Log Limit If **NO**, the logger records maximum 5 equal events during an arming period.

If **YES**, there is no limit to the equal events recorded in the logger.

Default: No.

 *In order to comply with the EN50131-1 and EN50131-3 standards, this option should be **NO**.*

Panel AS Tamper In this option you can enable the functioning of the external siren about the Tamper. You can choose between: **AS Balanced Tamper** and **External siren tamper**.

Default: External siren tamper.

 *In order to comply with the EN50131-1 and EN50131-3 standards, this option should be **External siren tamper**.*

Supervised Siren If enabled, the Control Panel can detect and signal short circuits and interruption on the terminal **+A** line.

 *Terminal **+A** must be wired as indicated in “INSTALLATION>Connecting Signalling Devices>Supervised Outputs”.*

Dialer Priority Every event may perform the following actions:

- **Speaker:** Voice Message on AS100 Audio Station.
- **Digital/Vocal calls:** Digital or Voice calls on the telephone landline (PSTN) or on the GSM line (if the **ABS-GSM** Module is installed).
- **SMS:** sending an SMS by GSM (if the **ABS-GSM** Module is installed);
- **Receiver Event,** event reporting via GPRS to the Sur-Gard SYSTEM II / III receivers.

Choose the order of priority for actions:

- Speaker - Digital/Voice Calls - SMS - Receiver Event;
- Speaker - SMS - Digital/Voice Calls - Receiver Event;
- Speaker - Receiver Event - Digital/Voice Calls - SMS;
- Speaker - Receiver Event - SMS - Digital/Voice Calls;
- Speaker - Digital/Voice Calls - Receiver Event - SMS;
- Speaker - SMS - Receiver Event - Digital/Voice Calls.

Default: Speaker - SMS - Digital/Voice Calls - Receiver Event.

Hardware Type This is a read-only option that shows the type of electronic card in the control panel:

- **Standard Audio Quality;**
- **Enhanced Audio Quality.**

Reset alarm/tamper memory on arming (Master code - keys)

If enabled, the alarm and tamper events stored during an arming period will be deleted the next time the system is armed using a Master Code, a Normal Code or a Key.

Default: enabled.

☞ *ONLY the memory relating to the common Partitions with PIN/Key and Keypad/Reader will be deleted.*

☞ *If the **Don't allow Master user to clear tamper memory (T014)** option is enabled ONLY the alarm events will be deleted.*

Don't allow Master user to clear tamper memory (T014)

If this option is enabled the user cannot clear the tamper memory.

Default: disabled

■ **Time Options**

Date / Time Set Date and the Time of the Control Panel.

☞ *Date and Time can be programmed also by keypad.*

Periodic Test Transmission time Set the date and the time of the first **Periodic Test**.

Periodic Test Transmission interval Set the time that must elapse between a **Periodic Test** and the next.

Valid entries: 0 through 65,535 minutes.

🔊 *In order to comply with the EN50136-2-1 standards, the option **Periodic Test Transmission** should **ENABLED** and the **Periodic Test Transmission interval** **MUST NOT** be more than 1,500 minutes (25 hours).*

Installer Maintenance Time Set the date and the time of the first **Installer Maintenance** event.

Installer Maintenance Interval Set the time that must elapse between a **Installer Maintenance** event and the next.

Valid entries: 0 through 65,535 minutes.

Surveillance Maintenance Time Set the date and the time of the first **Surveillance Maintenance on Panel** event.

Surveillance Maintenance interval Set the time that must elapse between a **Surveillance Maintenance on Panel** event and the next.

Valid entries: 0 through 65,535 minutes.

Daylight saving time/Daylight saving time - restored

If required, change the date and hour for Summer time begins/ends:

- the Panel moves **1 hour forward** its clock, on date and time set for the **Daylight saving time** options;
- the Panel moves **1 hour back** its clock, on date and time set for the **Daylight saving time - restored** options;

The system will signal Automatic Changeover by:

- switching ON the ▲ LED.

☞ *The ▲ LED signals several different types of Trouble events. If signalling is due to the Standard time/Summer time changeover, the Keypad (in View Trouble Mode) will show the daylighttimeledft message.*

Default: the Panel moves its clock 1 hour forward at 2 AM of the last March's Sunday and 1 hour back at 3 AM of the last October's Sunday, until 2030.

■ **Received Call Options**

☞ *This options refer to the Teleservice via PSNT ONLY.*

Phone number Enter the Teleservice Telephone Number.

Call Back Enabled If this option is Enabled, the Control panel will call the set telephone number (refer to **Phone Number**). In this way, ONLY authorized persons can access the Teleservice function.

Number of Rings Set the number of rings the Control panel must allow before answering an incoming call.

☞ *If the **Double call** option is enabled, the **Number of Rings** will be ignored (refer to "Double call" below).*

Double Call Enable This option will allow the Control Panel to share the telephone line with another answering device (answering machine, fax, etc.). Under normal circumstances, the device which allows the least number of rings will answer any incoming calls. However, if this option is Enabled, the Control panel will override the other answering device when it recognizes the Double Call sequence.

Double Call sequence: the caller must allow no more than 2 rings, then hang up and callback within 60 seconds. The Control panel will answer on the first ring of the second call.

☞ *The other answering device must be programmed to answer after 3 or more rings.*

■ Phone Options

Call Confirmation If this option is **enabled**, the Control Panel will not consider a call successful until the call receiver presses the star key on the telephone keypad, in order to generate a feedback signal.

Default: Enabled.

 *If this option is enabled, you should include a request for the feed back signal (press star) in the message.*

Call attempts Set the maximum number of Call attempts for each Telephone Number.

You have the following preset, unmodifiable, delays between call attempts:

- approx. 10 s between attempts to digital numbers;
- approx. 25 s between attempts to different vocal numbers;
- approx. 75 s between attempts to the same vocal number.

Valid entries: 1 to 99. **Default:** 4.

 *In order to comply with the EN50136-2-3 and EN50136-2-4 standards, the **Call attempts** option MUST NOT be less than 2 and more than 4.*

Voice in line If this option is ENABLED, the Voice message will be played after detection of a voice response. If the Control Panel does not detect a voice response before the **Wait voice timeout** ends, it will hang-up and generate a **Dialler action failed** event.

Default: Enabled.

Wait voice timeout Set the pause after dialling. If the Control Panel does not detect a voice answer before the **Wait voice timeout** ends, it will hang-up and generate a **Dialler action failed** event.

 *The **Wait voice timeout** applies to the **Voice on Line** option.*

Valid entries: 0 through 240 seconds, in 1 second steps.
Default: 30 seconds.

Transmission Delay Enabled If this option is ENABLED, the Voice message will be played when the programmed **Wait after select** expires.

If both **Voice in line** and **Transmission Delay** options are DISABLED, the Voice message will be played after dialling.

 *All calls that comply with the programmed **Send Message After** conditions will be considered Successful. However, only the **Voice in Line** option ensures a proper response to calls, therefore, if you disable this option or enable the **Transmission Delay** option, you should also enable **Call Confirmation** option.*

Voice Message Transmission Delay Set the pause between the end of dialling and the Voice Message announcement.

 *The **Voice Message Transmission Delay** applies to the **Transmission Delay Enabled** option.*

Valid entries: 0 through 240 seconds, in 1-second steps.
Default: 30 seconds.

Repetition Set the number of times the Control Panel must repeat the Voice Message.

Valid entries: 1 through 99.

Default: 3.

 *In order to comply with the EN50136-2-4 standards, the **Repetition** option MUST NOT be more than 8.*

Audio session timeout Set the two way audio session time.

Valid entries: 0 through 240 s (4 minutes), in 1-s steps.

Default: 30 seconds.

Line check If this option is ENABLED, the Control Panel will supervise the telephone line.

Default: Disabled.

 *In order to comply with the EN50131-1 and EN50131-3 standards, this option must be ENABLED*

The system will signal “Line down” (i.e. voltage on the [L.E.] terminals less than 3 V) by:

- turning ON the ▲⁶ LED;
- generating the Line Trouble signal — an X (blinking) above the  icon;
- generating the **Telephone line trouble** event.

The Control Panel will signal “Line restoral” (voltage on the [L.E.] terminals more than 3 V for the programmed **Pstn Line Restore**) by:

- turning OFF the ▲ LED (i.e. unless there are other faults);
- clearing the Trouble signal;
- terminating the **Telephone line trouble** event.

This option must be **disabled** when the Control Panel is not connected to a telephone line, otherwise, the **Telephone line trouble** event will be signalled persistently.

Tone check If this option is ENABLED, the Control Panel will check for the dialling tone before dialling. If the dialling tone is not detected during 30 seconds, the Control Panel will hang-up and retry.

Don't Check Incoming Call If the Control Panel makes a call, and this option is disabled, the control panel checks if there are incoming calls before dialling the number. In this case, wait.

Default: Enabled.

6 The ▲ LED signals several different types of Trouble events. If the signal is due to telephone line trouble, the Keypad (in View Trouble Mode) will show the **Tel.Lin.Failure** message.

Pstn Line Restoral Time This option will allow you to setup the time the telephone line voltage must be over 3 V so the Control Panel will signal “Line restoral” (refer to “Line check”).

Teleservice This option will allow you to enable the Phone number for Teleservice.

A standard modem and the BOSS application will allow you to provide the Teleservice function (access to the Control Panel via telephone).

Teleservice calls can be made by the installer (Teleservice calls to the Control Panel require User authorization), or by the User (if the Control Panel has been setup to perform the automatic **Test Event**).

When the Control Panel generates a Teleservice call (manually, by User request, or automatically via the **Callback** or **Enable Test Call** options — these options must be Enabled), it will dial the programmed numbers until a call is successful, or until the programmed call **Attempts** cycle ends.

Answering machine This option will allow you to enable the Answering machine.

The Answering Machine function will allow you to record a Voice Answer Message. The message will be played each time the Control Panel answers a call after the programmed number of **Rings**.

 *The Answering Machine function can be Enabled/Disabled by the User (refer to “Enable/Disable Answering Machine” in the USER MANUAL).*

If the Teleservice function is also Enabled, the Control Panel will emit a beep, wait approximately 6 seconds for the Modem to respond (if connected) and, if no response is detected, will play the Message. If the Answering Machine Message has not been recorded the Control Panel will emit a beep.

Answering Machine Enabled Channels Select the channel used by the Control Panel to answer the phone calls:

- **Only PSTN**, the Control Panel will answer ONLY calls made to its PSTN phone number;
- **Only GSM**, the Control Panel will answer ONLY calls made to its GSM phone number;
- **PSTN and GSM**, the Control Panel will answer calls made to both its PSTN and its GSM phone number.

Default: Only PSTN.

 *The **Present** and **Enabled** options in the **GSM** option group must be **ENABLED** to set this option.*

Vocal Guide If this option is enabled (default), a vocal guide will support the user in the remotely control panel management via a telephone that support the DTMF tones (refer to “OPERATING THE SYSTEM FROM A TELEPHONE” on the User Manual for further information). After listening to the welcome message, will be played the following messages.

- n.159: Welcome. Press pound.
- n.160: Enter code followed by pound.
- n.161: Goodbye. Please hang-up.
- n.162: Alarm call in stand-by. Please hang-up.

- n.163 (Menu 1): Press one for vocal functions.
- n.173 (Sub Menu 1/1): Press one to switch between talking and audio verification.
- n.174 (Sub Menu 1/2): Press two for two-way call.
- n.175 (Sub Menu 1/4): Press four to reduce audio verification sensitivity.
- n.176 (Sub Menu 1/5): Press five for standard audio verification sensitivity.
- n.177 (Sub Menu 1/6): Press six to increase audio verification sensitivity.
- n.164 (Menu 2): Press two for zone or partition status.
- n.178 (Sub Menu 2/1): Press one then enter three digit partition ID.
- n.179 (Sub Menu 2/2): Press two then enter three digit zone ID.
- n.165 (Menu 3): Press three for output activation.
- n.180 (Sub Menu 3/1): Enter two digit output ID then press one for activation.
- n.181 (Sub Menu 3/0): Enter two digit output ID then press zero for deactivation.
- n.166 (Menu 4): Press four to arm disarm panel.
- n.182 (Sub Menu 4/1): Press one to arm away.
- n.183 (Sub Menu 4/2): Press two to disarm.
- n.184 (Sub Menu 4/3): Press three to arm stay type A.
- n.185 (Sub Menu 4/4): Press four to arm stay type B.
- n.186 (Sub Menu 4/5): Press five to arm stay type C.
- n.187 (Sub Menu 4/6): Press six to arm stay type D.
- n.167 (Menu 5): Press five to arm disarm partitions.
- n.188 (Sub Menu 5/1): Enter two digit partition ID then press one to arm away.
- n.189 (Sub Menu 5/2): Enter two digit partition ID then press two to disarm.
- n.190 (Sub Menu 5/3): enter two digit partition ID then press three to arm stay A.
- n.191 (Sub Menu 5/4): Enter two digit partition ID then press four to arm stay B.
- n.168 (Menu 6): press six to enable disable installer.
- n.192 (Sub Menu 6/1): Press one to enable installer.
- n.193 (Sub Menu 6/0): Press zero to disable installer.
- n.169 (Menu 7): Press seven to clear call queue.
- n.170 (Menu 8): Press eight to reset alarms.
- n.171 (Menu 9): Press nine to disable code.
- n.172 (Menu star): Press star to end call, pound for main menu.

Messages from the No 159, to No. 193 of the Vocal Guide have already recorded. The instructions of the recorded vocal messages, and some examples of typical messages can be recorded by the installer.

 *If this option is disabled, the Control panel anyway answer with voice messages to the status requests.*

DTMF Control If this option is enabled, the user can remotely manage the control panel, via a telephone that support the DTMF tones (refer to “OPERATING THE SYSTEM FROM A TELEPHONE” on the User Manual for further information).

Default: Enabled.

 *Adjust the **Speaker Volume** and **Microphone Volume** on the GSM module (see the **GSM** option group) to resolve any problems in managing the control panel through the DTMF tones via the GSM.*

Disable Siren for Audio Session If during a audio session (listen-in and/or two-way Talk) and the siren is active, if this option is enabled (Yes), the siren will switch off.
Default: No.

■ Advanced Call Options

Country Selection for tone setting Select the country for the tone setting.

If the **Tone check** option is enabled (see **Phone options**) in this menu it is necessary to select the country for the Tone setting: the values of the options **Frequency Tone, Continuous, Tone Check, Tones 1-On, Tones 1-Off, Tones 2-On, Tones 2-Off, Tones 3-On, Tones 3-Off** for the Dial Tone, for the Congestion Tone and the Busy Tone will be automatically determined.

 *If a country is not on the list it is necessary to select **Custom** and set the options listed above.*

■ EN50131

 *In order to comply with the EN50131 Standards, ALL the following options must be **ENABLED**.*

Refuse arming on incomplete exit condition It is possible that the Control Panel is ready for arming also whit open zones if these zones are programmed as **Exit Delay**.

If this option is **ENABLED**, the Partitions are NOT armed if there are zone still open at the end of the **Exit Delay**.

Refuse arming on keyfob If enabled, it is NOT possible to arm the Partitions using the keyfob in the presence of some of the block conditions (see “USER MANUAL > APPENDIX > Arming block conditions”).

Apply EN50131 to Scheduler If enabled, it is NOT possible to arm the Partitions using the Scheduler in the presence of some of the block conditions (see “USER MANUAL > APPENDIX > Arming block conditions”).

Refused arming on Command Zones If enabled, it is NOT possible to arm the Partitions using the Command Zones in the presence of some of the block conditions (see “USER MANUAL > APPENDIX > Arming block conditions”).

Apply EN50131 to SMS Arming If enabled, it is NOT possible to arm the Partitions via SMS in the presence of some of the block conditions (see “USER MANUAL > APPENDIX > Arming block conditions”).

Events and Actions

The **Events-Actions** page determines how the system will operate:

- the first column shows the Control Panel's events;
- the second column shows the details relevant to the event selected on the first column;
- the table will allow you to associate the selected event with the **Outputs, Phone Numbers, Messages** and **Contact ID**, as described following.

■ Outputs

This subgroup of options is there for setting Output activation by events: up to three outputs for each event can be selected.

 *A Bistable Output restore to standby status when the event ends.
A Monostable Output restore to standby status when its **ON Time** ends.*

Enabled If disabled (default), the event does NOT activate the outputs.

If **ENABLED**, when the event occurs, it activates the outputs selected in the options **First Output, Second Output**, and **Third Output**.

First\Second\Third Output Select the Outputs that the event must activate when it occurs: you can set up to three outputs for each event.

■ Telephone

Telephone If disabled, the event does NOT make any telephone calls.

If **ENABLED**, the event calls the numbers selected (see **Telephone Numbers**).

Default: see Table 9.

Phone Numbers If disabled, the event does NOT call the respective telephone number.

If **ENABLED** (default), the event calls the respective telephone number (see the **Phonebook** options group).

 *The Control Panel will send either a Voice Message or a Reporting Code depending on the **Type** set for the Phone Number in the Phonebook Group.*

 *The Control Panel will call either ALL programmed Phone numbers or the programmed Phone numbers until one call is successful, depending on the options **Call All Voice** and **Call All Digital**.*

■ Voice Messages

This subgroup of options is for setting the playing of Voice Messages due to an event: up to three Voice Messages can be selected for each event.

The Voice Messages may be played by the loudspeaker of the AS100 (see the **AS100** option) and/or sent to the programmed telephone numbers (see the **Telephone** and **Telephone Numbers** options).

AS100 If disabled (default), the event DOES NOT play the Voice Messages.

If ENABLED, when the event occurs, the Voice Messages selected in the options **First Message**, **Second Message**, and **Third Message** are played.

First/Second/Third Message Select the messages that the Control Panel must play for the event.

When the event **OCCURS**, the following messages are played in sequence:

- Message nr. 1 (Welcome), ONLY if the **Telephone** option is enabled;
- Message nr. 2 (Alarm) for alarm events or, Message nr. 3 (Tamper) tamper events or, Message nr. 4 (Fault) for fault events or, Message nr. 8 (General Activation) for other events.
- First Message, Second Message and Third Message.

When the event **ENDS**, the following messages are played in sequence:

- Message nr. 1 (Welcome), ONLY if the **Telephone** option is enable;
- Message nr. 5 (Restore Alarm) for alarm events or, Message nr. 6 (Restore Tamper) for tamper events or, Message nr. 7 (Restore Fault) for Fault Events or, Message nr. 9 (Restore General Activation) for other events;
- First Message, Second Message and Third Message.

 *The selected Messages will be sent to the **Voice Dialler** Phone Numbers (see "Phonebook").*

 *The Voice Messages will be sent to the telephone numbers ONLY if the option **Send Restore Over Voice** is enabled (see below in this section).*

■ Telemonitoring

The options described below are for reporting Events in digital format via PSTN, GSM and GPRS.

Receiver If enabled, the control panel will send the event via GPRS (requires GSM module) to a Sur-Gard SYSTEM II / III receiver, as set in the **GSM** group.

Default: Disabled.

 *The **Receiver** is disabled when the option **Receiver for Digital Call Failed** is enabled.*

Receiver for Digital Call Failed If enabled, the control panel sends the event via GPRS (requires GSM module) to a Sur-Gard SYSTEM II / III receiver, as set in the **GSM** group, ONLY if it fails to send it via PSTN/GSM.

Default: Disabled.

 *The option **Receiver for Digital Call Failed** is disabled when the **Receiver** option is enabled.*

Digital Call for Receiver Failed If enabled, the control panel will send the event via PSTN/GSM when it fails to send to the receiver via GPRS.

Default: disabled.

 *The **Digital Call for Receiver Failed** option is blocked if the **Receiver** option is disabled or if the **Receiver for Digital Call Failed** option is enabled.*

Contact ID Identifier Enter the Contact ID Reporting Code for the event: the control panel sends the code, preceded by the digit **1** when the event OCCURS and by the digit **3** when the event ENDS.

 *The control panel sends the Contact ID reporting code when the event ends ONLY if the option **Send Restore Over Digital** is enabled (See below in this section).*

Event SIA Identifier Enter the SIA Reporting Code that the Control Panel must send when the relative event **OCCURS**.

Restore SIA Identifier Enter the SIA Reporting Code that the Control Panel must send when the relative event **ENDS**.

 *This option is not available for spot events.*

 *The control panel sends the SIA reporting code when the event ends ONLY if the option **Send Restore Over Digital** is enabled (See below in this section).*

 *The set Reporting Codes will be sent to the programmed **Digital** Type Phone Numbers (see "Phonebook").*

 *00 and 000 mean that the event will be not communicated.*

■ Restore

Send Restore Over Voice If disabled, the event does NOT send Voice Messages when it ends.

If ENABLED (default), when the event ends it sends the selected Voice Messages (see "First/Second/Third Message").

Send Restore Over Digital If disabled, the event does NOT send codes, via PSTN/GSM, when it ends. If ENABLED (default), when the event ends, it sends the programmed codes via PSTN/GSM (see **Contact ID Identifier** and **Restore SIA Identifier**).

Restore via SMS If disabled (default), the event does NOT send an SMS when it ends.

If ENABLED, when the event ends, the setup SMS is sent (see "SMS Enabled").

Send Restore Over Receiver If disabled, the event does NOT send codes via GPRS when it ends.

If ENABLED (default) when the event ends, it sends the programmed codes via GPRS (see **Contact ID Identifier** and **Restore SIA Identifier**).

■ Call All

Voice If this option is ENABLED (default), the Control Panel will call ALL the **Voice Dialer** Type phone numbers for the event (see **Telephone Numbers**).

If this option is disabled, the Control Panel will call the **Voice Dialer** Type phone numbers for the event (see **Telephone Numbers**) until a call ends successfully: the other event's numbers will NOT be called.

Digital If this option is ENABLED, the Control Panel will call ALL the **Digital Dialer** Type phone numbers for the event (see **Telephone Numbers**).

If this option is DISABLED (default), the Control Panel will call the **Digital Dialer** Type phone numbers for the event (see **Telephone Numbers**) until a call ends successfully: the other event's numbers will NOT be called.

■ SMS

This sub-group of options involves settings for SMS messages that must be sent by the events.

SMS Enabled If disabled (default), the event does NOT send SMS.

If ENABLED, the event sends an SMS messages to the numbers selected in the option **SMS Tel. Numbers**.

When the event OCCURS, the SMS message consists of the following parts (See the **SMS Messages** option group):

- SMS n. 1 (Panel Header);
- SMS n. 2 (Alarm) for alarms or
SMS n. 3 (Tamper) for tampers or
SMS n. 4 (Fault) for troubles or
SMS n. 8 (Generic) for other events;
- the SMS message selected in the option **SMS Text**.

When the event ENDS, the SMS message consists of the following parts (see the **SMS Messages** option group):

- SMS n. 1 (Panel Header);
- SMS n. 5 (Restoral Alarm) for alarms or
SMS n. 6 (Restoral Tamper) for tampers or
SMS n. 7 (Restoral Fault) for troubles or
SMS n. 9 (Restoral Generic) for other events;
- the SMS message selected in the option **SMS Text**.

 *The SMS will be sent only if the option **Restore via SMS** is ENABLED.*

SMS if Voice Call Failed If disabled (default), the event sends the SMS messages to ALL the numbers selected.

If ENABLED, the event sends SMS messages ONLY to the numbers to which the voice call failed.

SMS Text Select the SMS message that the event should send (see the **SMS Messages** option group).

Default: none.

SMS Tel. Numbers If disabled, the event does NOT send an SMS to the respective Telephone Number. If ENABLED (default), the event sends the programmed SMS message to the respective Telephone Number (See the **Phonebook** option group).

■ Event Description

This section describes the conditions that generate, and terminate each event.

Zone Events Table 10 shows Zone events associated with Zone alarm and Zone Tamper events.

A Zone event can be restored to standby by:

- changing the status (Armed/Disarmed) of a Partition the Zone is associated with;
- running Alarm Reset from a Keypad (the entered User PIN and Keypad must be jointly enabled on a Partition the Zone is associated with);
- running Alarm Stop from the Keypad (the entered User PIN and Keypad must be jointly enabled on a Partition the Zone is associated with);
- Using a valid Key on a Reader (both Key and Reader must be jointly Enabled on a Partition the Zone is associated with).

Partition Events Table 11 shows the Partition Events.

The Partition Events encase the Zone Events (Fire, 24h, Burglar, etc.). Each Zone event will in turn generate a Partition event (on the Partition the Zone is associated with). The Partition event will not terminate until all the Zone events end.

Partition Events can be restored to standby by:

- changing the Partition status (Armed/Disarmed);
- running **Alarm Reset** from a Keypad (the entered User PIN and Keypad must be jointly enabled on the Partition concerned);
- running **Alarm Stop** from the Keypad (the entered User PIN and Keypad must be jointly enabled on the Partition concerned);
- Using a valid Key on a Reader (both Key and Reader must be jointly enabled on the Partition concerned).

System Events These are Control Panel-generated warnings (e.g. Power Failure).

System Events can be restored to standby by:

- running **Alarm Reset** from a Keypad;
- running **Alarm Stop** from a Keypad;
- using a Key on a Reader.

Spot Events Spot events, such as **Recognized User PIN on Keypad**, are instant. Therefore, any action undertaken on termination would serve no purpose. Therefore:

- Bistable Outputs CANNOT be associated with Spot Events;
- Dialler and Digital Communicator Actions CANNOT be associated with restoral of Spot Events.

■ Remote Command Events

These events (Table 15) occur and end when the control panel receives an SMS with the following format:

```
#ABS#E#<PIN>#<ON|OFF>#<Command String>#<Text>
```

- **PIN:** a valid User PIN with the **SMS** option enabled (See the **Codes and Keys: User** option group).
- **ON|OFF:** ON makes the event occurs; OFF ends the event.
- **Command String:** the string entered in the **Command String** option (NOT case-sensitive).
- **Text:** an additional text ignored by the control panel that can be used by the user to assign a description to the command's SMS.

☞ The event occurs or ends **ONLY** if the PIN and the event share at least one Partition (see **Partitions**).

☞ The user can disable his own PIN by an SMS message, as described in the **USER MANUAL**.

The control panel sends confirmation by SMS when the operation has ended successfully (see the **USER MANUAL**).

☞ These events can also be controlled using an iPhone or Android smartphone via the **ABSOLUTA App** and via an **ABSOLUTA M-Touch** keypad (see “**USER MANUAL > Touch Keypad Operations > Scenarios**”).

Command String Type the string that needs to be sent in order for the event occurs or end (NOT case-sensitive).

The string may consist of up to 16 characters.

Default: empty.

Partitions If disabled, the respective Partition is NOT assigned to the event.

If **ENABLED** (default), the respective Partition is assigned to the event.

■ **Caller ID over GSM events**

These events (Table 16) occur when the GSM Module receives a call from the respective telephone number, as long as the **Caller ID** option for the telephone number is **ENABLED** (see the **Phonebook** option group).

☞ If the **Black List** option is **ENABLED** (see the **GSM** option group), the Telephone Number must have the **White List** option **ENABLED** (see the **Phonebook** option group), otherwise the control panel will hang up immediately and will **NOT** activate the event.

When the control panel receives the call from the telephone number, it hang up after a few rings and performs the programmed actions: then the control panel confirms this by ringing the telephone number, if the **Ringback Enabled** option is **ENABLED**.

☞ The ringback for confirmation may be delayed if there are other calls in the queue or may be lost if the queue is full or because of problems on the GSM network.

Ringback Enabled If disabled (default), the event will NOT ring back for confirmation.

If **ENABLED**, the event will ring back for confirmation.

■ **Default settings**

The default settings for the **Events and Actions** Option Group are made to provide a control panel that can be immediately operative with a minimum setup, as indicated on Table 9: the events listed on the **EVENTS** column, activate the Outputs shown on the **FIRST OUTPUT** column and send the Vocal Messages composed by the Messages shown on the **MESSAGE VIA TELEPHONE (PSTN)** columns, to ALL numbers in the **Phonebook**.

☞ In order to comply with the EN50131-1 and EN50131-3 standards, the **First Output, First Message and Telephone** options, about events on the Table 9, should **NOT** be modified, unless the **PSTN** option relevant to the **General System Tamper** event.

EVENTS	STATUS	FIRST OUTPUT	HEADER MESS.	MESSAGE VIA TELEPHONE		Telephone
				STATUS MESSAGE	FIRST MESSAGES	
Zone Alarm (Hold-up)	ON	—	1	2 (Alarm)	14 (Hold Up in progress)	Yes
	OFF	—	1	5 (Alarm Restoral)		
General System Alarm	ON	1	1	2 (Alarm)	—	Yes
	OFF	1	1	5 (Alarm Restoral)		
General System Tamper	ON	2	1	3 (Tamper)	—	Yes
	OFF	2	1	6 (Tamper Restoral)		
Warning Low Battery on Wireless Detector	ON	—	1	4 (Fault)	12 (Wireless Batteries)	Yes
	OFF	—	1	7 (Fault Restoral)		
Warning Mains Failure	ON	—	1	4 (Fault)	10 (Main AC)	Yes
	OFF	—	1	7 (Fault Restoral)		
Warning Low Battery	ON	—	1	4 (Fault)	11 (Panel Battery)	Yes
	OFF	—	1	7 (Fault Restoral)		
Battery Power Trouble	ON	—	1	4 (Fault)	11 (Panel Battery)	Yes
	OFF	—	1	7 (Fault Restoral)		
System Fault	ON	3	—	—	—	No
	OFF	3	—	—		
Automatic Arming Refused	ON	—	1	8 (General Activation)	13 (Auto arming failed)	Yes
	OFF	—	1	9 (Restore General Activation)		
Tamper on Armed System	ON	1	1	3 (Tamper)	—	Yes
	OFF	1	1	6 (Tamper Restoral)		

Table 9 Default settings for the **Events and Actions** Option Group: Output nr. 1 is assigned to terminals NC, COM, NO, +A and +N on the Main Board; Outputs nr. 2 and 3 are, respectively, assigned to terminals O1 and O2 on the Main Board.

EVENTS	OCCURS WHEN...	ENDS WHEN...
Alarm on zone	... the zone detects Alarm conditions ⁷ the zone restores to standby status.
Tamper on zone	... the zone detects Tamper conditions ⁷ Tamper conditions are no longer present on the zone.
Real time of Zone	... the voltage (resistance) on the Zone enters the Alarm Range.	... voltage (resistance) on the Zone restores to Standby Range.
Bypass Zone	... the Zone is bypassed.	... the Zone is restored.
Loss of Wireless Zone	... the Wireless Detector fails to send a valid signal during the Supervision Time.	... the Wireless Detector sends a valid signal during the Supervision Time.
Device Low Battery	... the battery of the Wireless Detector is low.	... the battery of the Wireless Detector is charged.

Table 10 Zone Events.

EVENTS	OCCURS WHEN...	ENDS WHEN...
Generic alarm on partition	... a Zone (any type) — associated with the Partition detects Alarm conditions.	... ALL Alarm events generated by Zones — associated with the Partition restore to standby.
Tamper alarm on partition	... a Zone — associated with the Partition detects Tamper conditions.	... ALL Tamper events generated by Zones — associated with the Partition restore to standby.
Fire Alarm on partition	... a Zone — associated with the Partition detects a Fire Alarm condition.	... ALL Fire Alarm events generated by Zones associated with the Partition restore to standby.
Memory Alarm on Partition	... the Generic alarm on partition Event occurs.	... the Partition Resets.
Alarm Stop on Partition	... a Stop Alarms request is made using a User PIN enabled for the Partition.	... the Control panel exits the Stop Alarms status.
Global Arming Partition	... the Partition Arms in Away Mode.	... the Partition Arms in Stay Mode or Stay Mode with Zero Delay.
Partial Arming Partition	... the Partition Arms in Stay Mode or Stay Mode with Zero Delay.	... the Partition Arms in Away Mode or Disarms.
Autoarming Warning Partition	... there are 10 minutes left before automatic arming of the partition.	SPOT EVENT!
Arming Refused on Partition	... a request of Arming on the partition was refused due to block condition.	SPOT EVENT!
Automatic Arming Refused on Partition	... during auto-arming, a Partition's zone is on alarm. At default, the Panel must inhibit the arming without activating the alarm.	SPOT EVENT!
Disarming Partition	... the Partition Disarms.	... the Partition Arms in Away Mode or Stay Mode or Stay with Zero Delay Mode.
Schedule on Partition	... the scheduler arms the partition.	...the scheduler disarms the partition.
Entry Time on Partition	... one of the Entry delay Zones belonging to the Partition detects Alarm conditions and the Partition is Armed in Stay or Away Mode.	... the Partition Entry Time expires or the Partition Disarms.
Exit Time on Partition	...the Partition Arms in Stay or Away Mode.	... the Partition Exit Time expires.
Chime on Partition	... a Zone with the Chime option belonging to the Partition detects Alarm conditions when the Partition is Disarmed.	SPOT EVENT!
Delinquency on Partition	... the Inactivity Time expires.	SPOT EVENT!
Negligence on Partition	... the Negligence Time expires.	SPOT EVENT!
Reset on Partition	... Alarms Reset is requested using a User PIN and Keypad jointly enabled for the Partition.	SPOT EVENT!

Table 11 Partition Events

⁷ Zones go into Alarm and Tamper status depending on the settings of the **Zone** Option Group.





EVENTS	OCCURS WHEN...	ENDS WHEN...
False Key Event	... a false Key is used on the Reader.	... the false Key has been removed from the Reader.
Valid Key	... the Key is used on a Reader.	... the Key is removed from the Reader.
Valid Key on Key Reader	... a valid Key is used on the Reader.	... the Key is removed from the Reader.
Valid Code	... arming, special arming, disarming or ENTER key is pressed after entry the User PIN.	SPOT EVENT!
Valid Code on Keypad	... arming, special arming, disarming or ENTER key is pressed after entry of a VALID User PIN on the Keypad.	SPOT EVENT!
Invalid Code on Keypad	... arming, special arming, disarming or ENTER key is pressed after entry of an INVALID User PIN on the Keypad.	SPOT EVENT!
Super Key 1 on keypad	... the Key 1 on the LCD Keypad (the Key  on the Touch Keypad) is pressed e hold for 3 (2) seconds.	SPOT EVENT!
Super Key 2 on keypad	... the key 2 on the LCD Keypad (the Key  on the Touch Keypad) is pressed e hold for 3 (2) seconds.	SPOT EVENT!
Super Key 3 on keypad	... the key 3 on the LCD Keypad (the Key  on the Touch Keypad) is pressed e hold for 3 (2) seconds.	SPOT EVENT!
Valid Keypad	... a button on the valid keypad has been pressed	SPOT EVENT!
Super Key on Keypad	... the button  of the Wireless key is pressed and held down for 2 seconds.	SPOT EVENT!
Keypad Low Battery	... the battery of the keypad is low.	... the battery is replaced.

Table 12 Key and PIN Events.

EVENTS	OCCURS WHEN...	ENDS WHEN...
General System Alarm	... a Zone — regardless of its Type and Partition detects Alarm conditions.	... ALL events generated by the zones of all Partitions restore to standby.
General System Tamper	... a Zone — regardless of its Partition detects Tamper conditions.	... ALL Tamper events generated by the zones of all Partitions restore to standby.
Warning Low Battery on Wireless Detector	... the battery of at least one Wireless Detector is low.	... the last Wireless Detector has closed and ALL Wireless Sensor batteries are charged.
Tamper on Main Unit	... the Control Panel Tamper switch opens.	... the Tamper switch restores.
Service Jumper Tamper on External Siren	... the SERVICE jumper is inserted	... the SERVICE jumper is removed.
Fault on External Siren	... External Siren Tamper is set for the Panel AS Tamper option AND the AS terminal is unbalanced.	... External Siren Tamper is set for the Panel AS Tamper option AND the [AS] terminal is balanced (grounded with a 10,000 ohm resistor).
Tamper on Internal Siren	... the external siren fails.	... ALL the fault conditions on the external siren restore.
Fault on Internal Siren	... the supervised output is tampered.	... the Output tamper event ends.
Tamper BPI Device	... the internal siren fails.	... ALL the fault conditions on the internal siren restore.
Wireless Receiver Tamper	... a BPI Device Tamper switch or Wall-Tamper switch open.	... all BPI Device Tamper switches and Wall-Tamper switches restore.
Warning BPI peripheral	... the Tamper switch or Wall-Tamper Switch of a Wireless Device is tripped.	... the Tamper and Wall-Tamper switches of all Wireless Devices are closed.
WLS Receiver Lost	... an enrolled BPI peripheral does not respond to the Control Panel.	... ALL the BPI peripherals respond to the Control Panel.
	... an enrolled Wireless Device does not respond to the Control Panel.	... ALL the enrolled Wireless Devices respond to the Control Panel.

Table 13 System Events (continued on next page).

EVENTS	OCCURS WHEN...	ENDS WHEN...
Warning Fuse	... at least one of the power terminals on the Main Board (+F, +B, +BPI, RED) is overloaded.	... the current drawn by the power terminals on the Main Board (+F, +B, +BPI, RED) drops below the permitted limit.
Warning Mains Failure	...Mains power has been off for the programmed Timeout (refer to "Options").	... Mains power is restored.
Warning Low Battery	... Battery voltage drops below 11.4 V.	... Battery voltage is restored to 12.3 V.
Battery Power Trouble	... a Battery fails the Dynamic Test (refer to "Connecting the Power supply" under "INSTALLING"), or fuse blows.	... Battery meets the Dynamic Test requirements, and fuse is replaced.
Telephone Line Trouble	... the Telephone Line voltage is less than 3 V for 45 seconds. If the Line check is disabled (refer to "Phone Options"), the event cannot be generated.	... the Telephone Line voltage is higher than 3 V for 45 seconds.
Warning Mains Failure on Power Station	... the programmed Timeout expires (refer to "Power stations" under "Configuration"). The Timeout will start when the Control Panel detects failure of the Mains supply — to one of the BPI Bus Power Supply Stations.	... Mains power is restored to ALL the BPI Bus Power Supply Stations.
Warning Low Battery on Power Station	... the Battery Voltage of a BPI Power Supply Station drops below 11.4V.	... the Battery voltage of ALL BPI Power Supply Stations restores to 12.3V.
Warning Power Trouble on Power Station	... the Battery of a Power Supply Station fails the Dynamic test or it is disconnected, or the Power Supply Station polarity inversion fuse blows.	... the Batteries of ALL the Power Supply Stations are connected and pass the Dynamic test and ALL the Power Supply Station polarity inversion fuses are replaced.
Battery not Connected on Power Station	... the voltage of a Power station battery is below 10.2 V at power up (the battery is exhausted).	... the voltage of ALL the Power station batteries rises above 12 V.
Battery Charger Trouble on Power Station	... the output voltage of a Power station power supply module is 0.5 V above or below the preset value.	... the output voltage of ALL the Power station power supply modules is 0.5 V above or below the preset value.
Short Circuit Output 1/2/3 on Power Station	... the current draw of a Power station output is over 1.8 A.	... the current draw of ALL the Power station outputs is over 1.8 A.
Battery Charger Disconnected on Power Station	... the output voltage of a Power station power supply module is 0.5 V above the preset value.	... the output voltage of ALL the Power station power supply modules is 0.5 V below or equal to the preset value.
Reset on Panel	... Alarms Reset is requested.	SPOT EVENT!
Chime on Panel	... a Zone with the Chime Attribute detects Alarm conditions when its Partition is Disarmed.	SPOT EVENT!
Negligence on Panel	... the Negligence Time expires.	SPOT EVENT!
Delinquency on Panel	... the Inactivity Time expires.	SPOT EVENT!
Test	... programmed (see System Options > Time > Periodic Test Transmission).	SPOT EVENT!
Installer Maintenance	... programmed (see System Options > Time > Installer Maintenance).	SPOT EVENT!
Balanced Tamper	... Balanced Tamper is set for the Panel AS Tamper option AND the AS terminal is unbalanced.	... Balanced Tamper is set for the Panel AS Tamper option AND the AS terminal is balanced (grounded with a 10,000 ohm resistor).
Tamper on Main Unit (Seized)	... the Control Panel wall-tamper switch opens.	...the Wall-Tamper switch restores.
Wireless Zone Loss on Panel	... at least one of the Wireless Detectors of a Supervised Wireless zone fails to send a valid signal during the Supervision Time.	... ALL Wireless Detectors send valid signals during the Supervision Time.

Table 13 System Events (continued on next page).





EVENTS	OCCURS WHEN...	ENDS WHEN...
Zone Alarm on Panel	... a zone detects Alarm conditions.	... ALL zones restore to standby status
Zone Tamper on Panel	... a zone detects Tamper conditions.	... ALL Tamper conditions are no longer present on the zones.
Real Time Zone on Panel	... the voltage (resistance) on a Zone enters the Alarm Range	... voltage (resistance) on ALL Zones restore to Standby Range.
Zone Bypass on Panel	... a Zone is bypassed.	... ALL Zones is restored.
Partition Alarm on Panel	... a Partition goes into Alarm Status.	... ALL Partition restore to Standby Status.
Partition Tamper on Panel	... a Partition goes into Tamper Status.	... ALL Partition restore to Standby Status.
Partial Arming on Panel	... a Partition Arms in Stay Mode or in Stay mode with Zero Delay.	... ALL Partitions Arm in Away Mode or Disarm.
Global Arming on Panel	... a Partition Arms in Away Mode.	... ALL Partitions Arm in Stay Mode or Stay mode with zero delay or Disarm.
Exit Time on Panel	... a Partition Arms in Stay or Away Mode.	... ALL Partition Exit Time expire
Entry Time on Panel	... a Entry Delay Zone goes into Alarm Status when its Partition is Armed in Stay or Away Mode.	... ALL Partition Entry Time expire or ALL Partitions Disarm.
Autoarming Warning on Panel	... an Auto-Arm Timeout starts.	... ALL Partition Arm or an Overtime Request is made.
Memory Alarm on Panel	... a Generic alarm on partition Event occurs.	... ALL Partition Reset.
Alarm Stop on Panel	... a Stop Alarm request is made.	... the Control panel exits the Stop Alarms Status.
Valid Key on Panel	... a valid Key is used on a Reader.	... ALL the Keys are removed from the Readers.
Valid Code on Panel	... arming, special arming, disarming or ENTER key is pressed after entry of a VALID User PIN.	SPOT EVENT!
Valid Keyfob on Panel	... a button on a valid keyfob has been pressed.	SPOT EVENT!
False Key on Panel	... a false Key is used on a Reader.	... ALL false Keys have been withdrawn from the Readers.
Invalid Code on Panel	... arming, special arming, disarming or ENTER key is pressed after entry of an INVALID User PIN.	SPOT EVENT!
Super Key 1 on Panel	... the key 1 on a LCD Keypad (the Key  on a Touch Keypad) is pressed e hold for 3 (2) seconds.	SPOT EVENT!
Super Key 2 on Panel	... the key 2 on a LCD Keypad (the Key  on a Touch Keypad) is pressed e hold for 3 (2) seconds.	SPOT EVENT!
Super Key 3 on Panel	... the key 3 on a LCD Keypad (the Key  on a Touch Keypad) is pressed e hold for 3 (2) seconds.	SPOT EVENT!
Keyfob Super Key on Panel	... the button  of a Wireless key is pressed and held down for 2 seconds.	SPOT EVENT!
Surveillance Maintenance on Panel	... the control Panel clock reaches the time and date scheduled for the maintenance of the Security Service.	SPOT EVENT!
Arm Refused on Panel	... a request of Arming was refused due to block condition.	SPOT EVENT!
Panel Fault	... a fault happens on the control panel.	... the last fault on the control panel restores.
System Fault	... a fault happens on the system.	... the last fault on the system restores.
Zone Detector Fault	... a Zone detects a fault condition.	... ALL the zones return to standby status.

Table 13 System Events (continued on next page).

EVENTS	OCCURS WHEN...	ENDS WHEN...
Automatic Arming Refused	... during auto-arming, a zone is on alarm. At default, the Panel must inhibit the arming without activating the alarm.	SPOT EVENT!
Tamper on Armed System	... an Armed Partition's Zone is tampered.	... ALL the Armed Partition's Tampered Zones return to standby status.
GSM Absence	... the options Present and Enabled are ENABLED (see the GSM option group) and the control panel has been UNABLE to communicate with the GSM Module for 30 seconds).	... the options Present and Enabled are ENABLED (see the GSM option group) and the control panel succeeds in communicating with the GSM Module.
GSM Link Lost	... the GSM network is busy, there is no GSM signal, or there is a problem with the SIM card.	... the GSM network is free, GSM signal is present, and the GSM Module is communicating using the SIM card.
GSM Receiver 1 LOST	... the Present and Enabled options are ENABLED, the options for Receiver 1 are enabled (see GSM option group) and the GSM module has problems communicating with the receiver 1.	... the Present and Enabled options are ENABLED, the options for Receiver 1 are enabled (see GSM option group) and the GSM module is able to communicate with the receiver 1.
GSM Receiver 2 LOST	... the Present and Enabled options are ENABLED, the options for Receiver 2 are enabled (see GSM option group) and the GSM module has problems communicating with the receiver 2.	... the Present and Enabled options are ENABLED, the options for Receiver 2 are enabled (see GSM option group) and the GSM module is able to communicate with the receiver 2.
GSM - Cellular Network Fault	... the Present and Enabled options are ENABLED (see GSM option group) and the GSM module has problems communicating with the GSM network.	... the Present and Enabled options are ENABLED (see GSM option group) and the GSM module is able to communicate with the GSM network.
Arming refused on command zones	... an arming request via a command zone has been refused due to block conditions.	SPOT EVENT!
Arming refused on keyfob	... an arming request via keyfob has been refused due to block conditions.	SPOT EVENT!

Table 13 System Events.

EVENTS	OCCURS WHEN...	ENDS WHEN...
Dialler Action Failed on Telephone	... a call, in Dialler mode, to the phone number failed.	SPOT EVENT!
Timer Event	... the timer switches ON.	... the timer switches OFF.

Table 14 Other Events.

Remote Command	... the control panel receives the following SMS: #ABS#E#<PIN>#ON#<Command String>#<Text> (see "Remote Command Events") or the appropriate command from the ABSOLUTA App or from an ABSOLUTA M-Touch keypad (see "USER MANUAL > Touch Keypad Operations > Scenarios").	... the control panel receives the following SMS: #ABS#E#<PIN>#OFF#<Command String>#<Text> (see "Remote Command Events") or the appropriate command from the ABSOLUTA App or from an ABSOLUTA M-Touch keypad (see "USER MANUAL > Touch Keypad Operations > Scenarios").
-----------------------	--	---

Table 15 Remote Command events.

Caller ID to Tel.	... the control panel receives a call from the telephone number (see "Caller ID over GSM events").	SPOT EVENT!
--------------------------	--	-------------

Table 16 Caller ID over GSM events.

Codes and Keys: User (PINs)

The User PIN allow the Users to access the system, by a Keypad, by a DTMF telephone, by SMS and by the BOSS's **Status** Page.

 *PIN n. 1 CANNOT access the system by phone.*

Each User PIN can be programmed to control specific functions and Partitions.

PIN The PIN is the combination of digits that allows access to PIN functions. The PIN can be a 4, 5 or 6 digit number.

Keypads and User PINs Each Keypad and User PIN can be programmed to control specific Partitions. Therefore, the outcome of a command entered at a Keypad depends on the User PIN and Keypad in use (commands will affect ONLY the Partitions common to both the User PIN and Keypad). This dual level of control greatly increases application flexibility, for example, a PIN can be programmed to control a certain group of Partitions when entered at one Keypad, and a different group when entered at another. This feature simplifies User control, as the same operation will have a different outcome on different Keypads.

Valid PIN Event Each time the Control Panel recognizes a Valid PIN, it will generate the **Valid PIN** Event. Like all other Control Panel Events, this Event can be assigned to an Output or Telephone Action — regardless of whether or not the PIN is enabled to request Control Panel actions. Therefore, an opportune combination of Events and Outputs will eliminate some of the hitches linked with access control and/or limitations.

PIN Transfer The *PIN Transfer* option allows the installer to upload or download the User PIN's with a PC connected serially to the control panel (USB or RS232), by Internet/GPRS (with the optional **ABS-GSM** Module), or using a USB key.

 *User PIN's CANNOT be uploaded or downloaded by phone because this type of connection does not offer the security needed for this type of information.*

The User needs to enable *PIN Transfer* as described in the section "LCD KEYPAD OPERATIONS > Program > Enable Installer (Teleservice) (2.2)" of the USER MANUAL then the installer should load the option **System Options > General > Allow installer access personal programming**.

 *When PIN Transfer is enabled, the installer can also use the keypad to program ALL the numbers in the Phone Book (see "LCD KEYPAD OPERATIONS > 2.8) Telephone Communicator").*

The **User** option group is to setup the User PINs as follow.

Label This option (maximum 16 characters) is to identify the User PIN in all the operations it is involved in (e.g. User's Name).



User Code If the *PIN Transfer* option is disabled, the masked PIN (a series of dots) appears. If the option *PIN Transfer* is ENABLED, the PIN is displayed clearly: type the desired PIN or press the  button to have the BOSS generate a random one; enter all "A" to disable the PIN.

Available If this option is enabled, the PIN can be programmed and used for system access. Many applications require fewer PINs. This option will allow you to enable only the required number of PINs, thus simplifying the programming process while increasing the security level. PINs which have not been made **Available** can be considered inexistent.

Active If enabled, the PIN can perform the operations for which it was programmed.

If disabled the PIN CANNOT access the system.

Default: ONLY enabled for PIN no. 1.

 *This option is read-only. ONLY a Master User PIN can change the status of this option (see "TOUCH KEYPAD OPERATIONS > (User) Menu > PIN", "LCD KEYPAD OPERATIONS > PIN Programming (2.5)", "TELEPHONE OPERATIONS > Disable Current User PIN ()" And "SMS OPERATIONS > Disabling a PIN" in the USER MANUAL.*

Keypad If this option is enabled the User PIN can manage the system by keypad.

Hold-up If this option is enabled, any Telephone actions (calls or reports) associated with the **Valid PIN** event (generated by the PIN concerned) will not be signalled on the keypad (i.e. will not appear over the  icon).

DTMF If this option is enabled the User PIN can manage the system by touchtone telephone.

SMS If ENABLED, the PIN can control some events by SMS (see "Events and Actions > Remote Command Events") and can Arm/Disarm the Partitions via SMS.

Default: enabled.

 *This option is NOT available for PIN N. 1.*

In And Group If this option is ENABLED, the PIN may be used to disable Partitions with the option **AND Keys/Codes-Num** set to **2 Keys and/or Codes** or **3 Keys and/or Codes** (see **Partitions** option group).
Default: enabled.

User type This option is to set the the actions that the User PIN can performs, as follow.

- **Master:** this type can perform all the operations.
- **Normal User:** this type allows Arm/Disarm operations, Alarm memory reset, Overtime requests.
- **Limited User:** this type allows Arm/Disarm operations, Alarm memory reset.
- **Patrol:** this type can disarm the PIN Partitions for the programmed Patrol Time. The Partition will rearm automatically when the Patrol Time ends, or when the Patrol PIN is entered again.

 *In order to comply with the EN50131-1 and EN50131-3 standards, the PIN n. 1's **User Type** must be **Master**.*

 *Only Master PINs can arm/disarm the panel through **Status** page. Normal, Limited and Patrol PINs CANNOT arm/disarm the panel through **Status** page.*

User Timer If this option is enabled, the Code will be able to perform its programmed functions ONLY during its Timer slots (refer to “Timers”).

Partitions If disabled, the PIN can NOT manage the partition.
If ENABLED, the PIN can manage the partition.
Default: ONLY partition n. 1 enabled.

Arming Mode A This option will allow you to set the **A** Mode Arming of the Partition:

- **Away**, Partition will Arm in Away mode;
- **Stay**, Partition will Arm in Stay mode;
- **Instant Stay**, Partition will Arm in Stay mode with zero delay (Instant);
- **Disarm**, Partition will Disarm;
- **No Action**, the Partition does NOT change its state.

Default: stay arming of partition 1.

Arming Mode B As for **Mode A** but for **B** Mode Arm commands at a Keypad.
Default: zero delay stay arming of partition 1.

Arming Mode C As for **Mode A** but for **C** Mode Arm commands at a Keypad.
Default: no action.

Arming Mode D As for **Mode A** but for **D** Mode Arm commands at a Keypad.
Default: no action.

Codes and Keys: Keys

This Option group is to setup the Digital Keys as follow.

Key Label This option is to enter a significant description for the key.

Key Enabled If this option is enabled the key can control the system.

If this option is disabled the key cannot control the system, however, it can still be programmed by a **Master PIN**.

Master PINs can toggle the Enabled status of the keys (also via the User Menu).

Key Arm Only If this option is enabled, the Key will be able to Arm its Partitions ONLY.

Disarm Only If this option is enabled, the key will ONLY disarm the partitions on which is enabled.

Silence Output If this option is ENABLED, the Key may silence Outputs (Stop Alarms).

When the Key is brought close to a Reader:

- if there are Outputs active due to alarm or tamper, they will be silenced (forced to standby mode);
- if the control panel is already in Silence mode, the Silence will be removed.

Silencing is signalled by the Reader's **green** and **red** indicators lights blinking quickly.

 *If this option is ENABLED, all the other options are disabled, except for the **Disarm Only** option; that is, a Key enabled for Silencing cannot perform other operations or vice versa.*

 *If option **EN50131** on the Reader is enabled, Outputs reactivate themselves for a new alarm or tamper.*

 *Silencing has NO effect on calls.*

Key Patrol If this option is enabled, the Key will be able to Disarm and Re-arm its Partitions during the programmed **Patrol Time**. If a Partition is disarmed by a Key with the Patrol option enabled, the Partition will Re-arm automatically when the programmed **Patrol time** of the Partition concerned expires.

Key Clear Panel Calls If this option is enabled, the Control Panel will clear the running call and all the queued calls — triggered by events associated with the Control panel — when the key is recognized.

Key Clear Calls on Partitions If this option is enabled, the Control Panel will clear the running call and all the queued calls — triggered by events associated with the Key Partitions — when the key is recognized.

In AND Group If this option is enabled, the Key must be used with another Key or Code to Disarm its Partitions, as set in the **And Keys Codes Num** option (refer to the "Partition" Option Group").

Key Timer If this option is enabled, the Key will be able to perform its programmed functions ONLY during its Timer slots (refer to "Timers").

Key Presence If this option is enabled, the Key can be programmed and used for system access. Many applications require fewer Keys. This option will allow you to enable only the required number of keys, thus simplifying the programming process while increasing the security level. keys which have not been made **Available** can be considered inexistent.

Partitions If disabled, the Key CANNOT manage the Partition. If ENABLED, the Key can manage the Partition. **Default:** ONLY Partition n. 1 is enabled.

Codes and Keys: Keyfobs

This Option group is to setup the Keyfobs (Wireless Keys), as follow.

Label This option is to enter a significant description of a keyfob.

Wireless Device Serial Number This option is for the ESN (Electronic Serial Number) of the Wireless key. The ESN will allow the Control Panel to identify the wireless key on the system. The ESN may comprise hexadecimal digits (A, B, C, D, E and F), in order to lower the risk of duplicate ESNs.

 *Some Wireless Devices have 5-digit and 6-digit ESNs (printed on back), use ONLY 6-digit ESNs with this Control Panel.*

Enabled If this option is enabled the Keyfob can control the system.

If this option is disabled the Keyfob cannot control the system, however, it can still be programmed by a **Master PIN**.

Master PINs can toggle the Enabled status of the keyFobs (also via the User Menu).

KeyFob Presence If this option is enabled, the Keyfob can be programmed and used for system access. Many applications require fewer Keys. This option will allow you to enable only the required number of Keyfobs, thus simplifying the programming process while increasing the security level. Keyfobs which are not present can be considered inexistent.

Timer If this option is enabled, the Keyfob will be able to perform its programmed functions ONLY during its Timer slots (refer to "Timers").

Partitions If enabled, the keyfob does NOT manage the partition. If ENABLED, the keyfob can manage the partition. **Default:** ONLY partition n. 1 enabled.

Mode A This option is to setup the action on the Partition when the Wireless key performs the **A** Mode Arming, as follow.

- **Away Arm:** Partition will Arm in Away mode.
 - **Stay Arm:** Partition will Arm in Stay mode.
 - **Instant Stay:** Partition will Arm in Stay mode with zero delay (Instant).
 - **Disarm:** Partition will Disarm:
 - **No Action:** the Partition does NOT change its state.
- Default:** Stay arming of Partition 1.

Mode B As per **Mode A** but for **B** Mode Arming. **Default:** Zero Delay Stay Arming of partition 1.

Event Schedule

The **Event Schedule** group options is to setup the automatic arming/disarming of the partitions at specific times, as follow. To automatic arming/disarming a Partition on a specific day, you must:

- enable a Time Table by ticking its **Enable** option;
- setup the time when the Partition requires to be Armed/Disarmed during the day, by clicking on the **Partitions** button of the Time Table;
- Apply the Time Table to the required day by selecting it on the Perpetual Calendar and by clicking on the **Apply** button;
- click on the **Enable/Disable** button to enable the Time Table on the selected day;
- enable Auto-Arming (by the **Enable Auto Arming** option in the **General System Options** or by the **Auto-Arm** option on the Keypad Mater User Menu).

 *In order to comply with the EN50131-1 and EN50131-3 standards, if a zone is in alarm during auto-arming, at default, the Panel inhibits the arming, without triggers alarms, and logs in memory the events and their causes. In addition, the Panel notifies the arming fail by the Voice Dialler: **Automatic Arming Refused on Partition** event enabled.*

■ Time table

You can setup up to 20 time Tables, as follow.

This is the Time Table ID. Any Time Table is identified by its ID number (#) and a specific colour. The ID number and colour are used to identify the Time Table on the Perpetual Calendar.

Title You can assign a significant name to the Time Table.

Type You can setup Daily and Weekly Time Tables.

- **Daily:** Daily Time Table applies to the selected days on the Perpetual Calendar, independently by the day of the week.
- **Weekly:** Weekly Time Table applying to the selected days on the Perpetual Calendar depending on the day of the week.

 *To setup the Weekly Type you need seven Time Tables, one for each day of the week, therefore the application asks you the confirmation for override the six Time Tables following the one selected.*

Edit By Clicking on the **Partition** button you can setup the relevant Time Table by means the **Partition Event Editor**, as described in the relevant paragraph.

 *The Partition button is active only if the **Enabled** box is checked.*

Week Day This column shows the week of day that the Weekly Time Table refers to: **MON** (Monday); **TUE** (Tuesday); **WED** (Wednesday); **THU** (Thursday); **FRI** (Friday); **SAT** (Saturday); **SUN** (Sunday).

Enabled This option let you to enable/disable the Time Table: enabled; disabled.

Apply By clicking on the **Apply** button you can apply the Time Table to the selected days on the Perpetual Calendar.

■ Partitions Event Editor

Each Time Table allow to you set up up to 8 arming events for each Partition.

For each arming event you can setup the type and the time when it will occur, as follow.

ARM Select the Action for the Partition:

- Away
- Stay
- Instant Stay
- Disarm
- No Action

Time Set the time when the selected action must occurs.

■ Perpetual Calendar

The Perpetual Calendar (the table on the right side of the Event Schedule Option Group) is to apply the set Time Tables to the required days, as follow.

Select the required days then click on the **Apply** button to apply the relative Time Table:

- to select discontinuous interval of days, keep holding the **Ctrl** key on the keyboard then click on the required days.
- to select continuous interval of days, click on the first day of the interval, then keep holding the **Shift** key on the keyboard, then click on the last day of the interval.

The colour and the ID number on a day indicate the Time Table for that day.

By moving the mouse pointer on a specific day, you can obtain the following information:

- the **ID Number** of to the Time Table applied to that day;
- the **Title** of to the Time Table applied to that day;
- the month of the selected day;
- the number of the selected day;
- the day of the week for the current year and for the next year.

Select Partition This menu is to select the Partitions to see on the Perpetual Calendar.

- All partitions:** the Perpetual Calendar shows the Time Tables for all Partitions.
- Partition:** the Perpetual Calendar shows the Time Tables for the selected Partition.

Enable/Disable This button is to enable/disable the Scheduler for specific days.

Select the required days on the Perpetual Calendar then select the **Enable/Disable** button to change the Scheduler status:

- the grey background indicates that the Scheduler is disabled;
- the coloured background indicates that the Scheduler is enabled.

Timers

The Timers group options is to setup the timers, as follow.

■ Time table

The Time Tables works as the same relevant to the Event Schedule (refer to “Time table” in the “Event Schedule” paragraph for more information) except for the following.

Edit By Clicking on the **Timers** button you can setup the relevant Time Table by means the **Timer Event Editor**, as described in the relevant paragraph.

■ Timer Event Editor

Each Time Table allow to you set up up to 4 ON Time and up to 4 OFF time for each Timer, as follow.

On Set the time when the Timer activates.

Off Set the time when the Timer deactivates.

 *In order that a timer active before midnight, remains active even after midnight, it must be programmed as follows: leave blank the OFF field, following the last day's activation. Set up at 00:00 the first activation (ON) for the next day.*

 *You must set **On 1** together with **Off 1**, **On 2** with **Off 2**, etc: other combinations are not allowed.*

■ Perpetual Calendar

The Perpetual Calendar (the table on the right side of the Timer Option Group) works as the same relevant to the Event Schedule (refer to “Perpetual Calendar” in the “Event Schedule” paragraph for more information) except for the following.

Select Timer The same of **Select Partition** for the Scheduler but relevant to the Timers.

Enable/Disable The same of **Enable/Disable** for the Scheduler but relevant to the Timers.

GSM

The **GSM** option is to setup the GSM Module as described below.

Present If this option is enabled, the options concerning the GSM Module can be set.

Default: disabled.

 *The control panel can use the GSM Module ONLY if this option is enabled.*

If this option is enabled and the control panel fails to communicate with the GSM Module for 30 seconds, the event **GSM Absence** occurs: the event ends when the control panel succeeds in communicating with the GSM Module.

Enabled If this option is disabled, the options concerning the GSM Module (maintenance) can be uploaded or downloaded.

Default: disabled.

 *The GSM Module may also be enabled/disabled from the Installer Menu and the User Menu.*

Black List If this option is enabled, the GSM Module will accept ONLY calls coming from numbers in the Phonebook with the **White List** option enabled.

SIM Phone Number Type the telephone number of the SIM card placed in the GSM Module (maximum 16 digits).

Speaker Volume Set the volume of the GSM Module's loudspeaker: this option determines the intensity of signals entering the GSM Module.

Microphone Volume Set the volume on the GSM Module's microphone: this option determines the intensity of the signals outgoing from the GSM Module.

 *If the volume on the microphone is too high, it may corrupt the DTMF tones produced by the control panel, making them unrecognizable.*

SMS Fault Text This option, together with the **SMS Fault Telephone Number** option, allows the GSM Module to send an SMS message independently when it fails to communicate with the Motherboard.

Type the message to be sent to the telephone numbers selected in the option **SMS Fault Telephone Number** when the GSM Module FAILS to communicate with the Motherboard.

Valid entries: up to 255 characters.

Default: no text.

SMS Fault Tel Number Select the Phone Numbers in the Phonebook to which the message typed in the option **SMS Fault Text** should be sent.

■ Pay As You Go

 *The pre-paid SIM CARD credit management service may be suspended at any time, at the discretion of each individual GSM network operator.*

This section can be used to send an SMS providing credit balance information (supplied by the operator) to the first number in the phonebook at regular intervals. Set the following options for a correct credit balance check request, in accordance with the type of operator used.

Enquire Type Select the enquiry type (**SMS, Call, Service Command**).

Enquire Number Type the phone number to call or to which an SMS message should be sent in order to request credit balance information.

Balance Message Type the string used to send SMS messages and to make requests via service commands.

The table below shows the values for the above options for some Italian mobile phone companies.

Options	Vodafone	Wind	TIM
Enquire Type	Call	Service Command	SMS
Enquire Number	404		40916
Balance Message		*123#	PRE CRE SIN

Enquire Interval Set the time after which the GSM Module should send a periodic SMS containing credit balance information (if supported by your telephone operator).

- **Days:** valid entries, 0 to 365.
- **Hours:** valid entries, 0 to 23.

■ App/BOSS Cellular Communication

This subgroup is for setting the GPRS connection for managing the control panel via the ABSOLUTA App and for Teleservice via BOSS.

App/BOSS APN Enter the APN (Access Point Name) supplied by the operator that provides the GPRS service.
Default: None.

 *Enter the correct APN for WAP/GPRS services or some features may be limited (for more information, please contact the operator of the service center).*

 *The App/BOSS APN is the same as the Main Receiver APN.*

App/BOSS Username If required, enter the Username supplied by the operator that provides the GPRS service.
Default: None.

 *App/BOSS Username is the same as the Main Receiver User Name.*

App/BOSS Password If required, enter the Password supplied by the operator that provides the GPRS service.
Default: None.

 *App/BOSS Password is the same as the Main Receiver Password.*

■ Cellular

This subgroup is for setting the GPRS connection for telemonitoring with Sur-Gard SYSTEM II / III receivers.

 *Bearing in mind the delays which may occur in transmission via GPRS, which are caused by the activities of the network manager, we recommend you program as many call attempts as possible, and that you also provide a backup telephone number which transmits alarms via GSM as well as via GPRS.*

DNIS Enter the DNIS number (Dialed Number Identification Service), if required.
Default: None.

Account Code Enter the Account Code provided by the Central Station.
Default: 0000FFFFFF.

Receiver Functionality Mode Select the operating mode of the receivers:

- **Primary and Backup**, the Backup Receiver will only be used when communication fails on the Main receiver;
- **Redundant**, events will be sent to the Main and Backup Receiver at the same time.

Default: Primary and Backup.

 *If Redundant is selected, the APN 2, APN 2 Username and APN Password CANNOT modified and are copied by the Main Receiver APN, the Main Receiver User Name and the Main Receiver Password respectively.*

Customer Account Enter the Customer Account provided by the Central Station: the Customer Account allows the Central Monitoring Station to identify the system.
Default: 0000.

Communication Protocol Select the protocol specified by the Central Station:

- SIA over FIBRO;
- Contact ID over FIBRO.

Default: Contact ID over FIBRO.

SIA Code for Panel Lost Event Enter the SIA Event code that must be sent when the GSM module cannot communicate with the Control Panel.

Default: 00.

CID Code for Panel Lost Event Enter the Contact ID Event code that must be sent when the GSM module cannot communicate with the Control Panel.

Default: 000.

GSM Network Fault Delay Set how long the GSM network must be faulty before a **GSM Link Lost** event is triggered and a **GSM network** failure is reported. If the GSM network is restored before the end of the programmed time, the event has NOT occurred and the fault is NOT reported. The **GSM Net Fail** event is still stored in the Event Log however.

Valid entries: from 0 (delay disabled) to 255 minutes.

Default: 0.

GPRS Network Fault Delay Set how long the GPRS network must be faulty before a **GSM - Cellular Network Fault** event is triggered and a **GPRS network** failure is reported. If the GPRS network is restored before the end of the programmed time, the event has NOT occurred and the fault is NOT reported. The **Data Network Lost** event is still stored in the Event Log however.

Valid entries: from 0 (delay disabled) to 255 minutes.

Default: 0.

Receiver 1 IP Address (Receiver 2 IP Address) Enter the IP address of the Main (Backup) receiver provided by the Central Station.

Default: 0.0.0.0.

 *The **Receiver 2 IP Address** is locked until the **Main Receiver APN** is entered.*

Receiver 1 Remote Port (Receiver 2 Remote Port) Enter the Port number of the Main (Backup) Receiver provided by the Central Station.

Default: 3061.

 *The **Receiver 2 Remote Port** is locked until the **Main Receiver APN** is entered.*

Main Receiver APN (APN 2) Enter the APN (Access Point Name) for the Main (Backup) Receiver supplied by the operator that provides the GPRS service.

Default: None.

 *Enter the correct APN for WAP/GPRS services or some features may be limited (for more information, please contact the operator of the service center).*

 *The **Main Receiver APN** is the same as the **App/BOSS APN**.*

 ***APN 2** is locked until the **Main Receiver APN** is entered.*

Main Receiver User Name (APN 2 Username) If required, enter the Username for the Main (Backup) receiver supplied by the operator that provides the GPRS service.

Default: None.

 *The **Main Receiver User name** is the same as the **App/BOSS Username**.*

 *The **APN 2 Username** is locked until the **Main Receiver APN** is entered.*

Main Receiver Password (APN 2 Password) If required, enter the Password for the Main (Backup) receiver supplied by the operator that provides the GPRS service.

Default: None.

 *The **Main Receiver Password** is the same as the **App/BOSS Password**.*

 *The **APN 2 Password** is locked until the **Main Receiver APN** is entered.*

Supervision 1 Enabled (Supervision 2 Enabled) If enabled, the GSM module periodically sends a Supervision Event to the Control Station and if it doesn't receive a response it generates a **System > GSM Receiver 1 Lost (GSM receiver 2 Lost)** Event.

Default: disabled.

 *The **Supervision 1 Enabled (Supervision 2 Enabled)** option is locked until the **Main Receiver APN (APN 2)** is entered.*

Supervision time 1 (Supervision time 2) Enter the interval between an event and the subsequent supervision event.

Valid entries: 60 to 65,535 seconds.

Default: 60 seconds.

 *The **Supervision time 1 (Supervision time 2)** option is locked until the **Main Receiver APN (APN 2)** is entered.*

■ Disabling event transmission to the receivers

To disable the transmission of events to a receiver:

- enter 0.0.0.0 for the IP address, or
- set the remote port to 0, or
- set a blank APN.

 *The last option is recommended ONLY for disabling the Backup receiver since the Main receiver APN is the same one used by the APP/BOSS on the GPRS.*

SMS Messages

This group of options is to setup SMS Messages, as described below.

Label Assign a label to the message: this information is not saved in the control panel, which is why the icon for downloading the option does NOT change its appearance when modified.

Message Enter the required message.

Downloading/Uploading

Once the options have been set up, they must be downloaded to the Control Panel concerned, as follows.

To perform the Downloading/Uploading you must:

- disarm all the partitions;
- exit from the Installer Menu;
- enter the Installer PIN when required (default **0104**).

You can Downloading/Uploading the options:

- on-site, by connecting the Control Panel to the PC;
- on site, by means a USB key;

 *You must remove any connection from the smaller USB serial port (21) to perform downloading/uploading by an USB key.*

- remotely, by phone on a landline (PSTN);
- remotely, over the Internet (GPRS).

■ Connecting the Control Panel to the PC

You can connect the Control Panel to a PC:

- locally, via the **RS232** Serial Port;
- locally, via the **USB** Serial Port;
- remotely, via the **Landline** (PSTN);
- remotely, over the Internet (**GPRS**).

Connecting via RS232 Serial Port

1. Connect the Control Panel RS232 serial port (**10, PC-LINK**) to a free RS232 serial port on the PC using the **PC-LINK** cable (accessory item), as shown on Figure 25.
2. Select the PC serial port used for connection with the Control Panel, as follows:
 - select **Modem Manager Configuration** from the **Tools** menu;
 - select the **PCLINK - COM1** connection;
 - select the PC serial port where the Control Panel is connected to, from the **Port** menu;
 - click **OK**.

Connecting via USB Serial Port

1. Connect the Control Panel USB serial port (**21**) to a free USB serial port on the PC using a **USB** cable (accessory item).
2. Select the PC serial port used for connection with the Control Panel, as follows:
 - select **Modem Manager Configuration** from the **Tools** menu;
 - select the **PCLINK - COM1** connection;
 - select the PC serial port where the Control Panel is connected to, from the **Port** menu;
 - click **OK**.

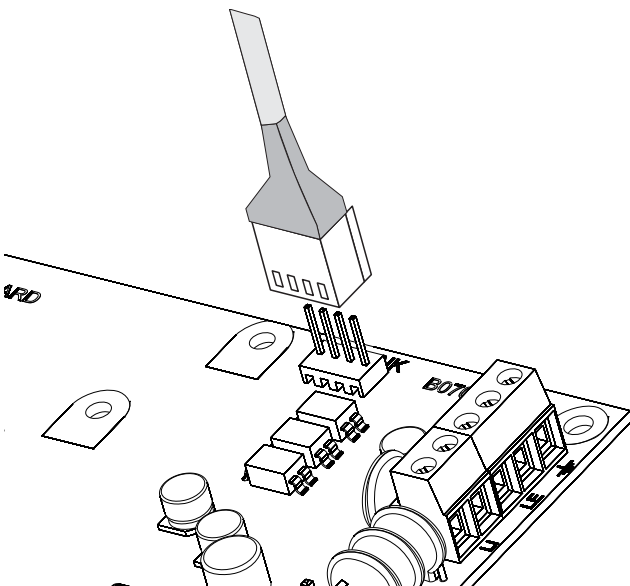

Figure 25 PC-Link connection.

Connecting via the Telephone Line You can connect the Control Panel to a remote PC via the telephone line. To do this:





- you must connect the Control Panel to the Telephone Line;
- you need an internal/external **56K Modem** that support either the **V.22** or **V.23** standard protocol, installed/connected to the PC used to perform the downloading/uploading.

Internet (GPRS) Download/Upload Options can be uploaded/downloaded over the Internet (GPRS). To do this:

- the PC on which BOSS is installed must be connected to the Internet;
- the PC must have a public IP address and a public port for incoming connections to the BOSS application;
- the firewall and the router must allow the PC to connect the public port to port **51004** of the BOSS application;
- make sure you can access the public port of the router from another PC to see if the BOSS application can be reached from the device;
- the **ABS-GSM** Module must be installed on the control panel and the options **Present** and **Enabled** in the **GSM** option group must be **ENABLED**;
- a SIM card must be inserted in the GSM Module and the credit on the SIM must be sufficient for GPRS services.

To open communications over the Internet (GPRS), proceed as described below.

1. Select the Customer Account properties (right click on the Customer Account's name, then **Properties**).
2. Select the type of control panel (for example, Absoluta 104 v2.0) from **Account Settings**.
3. Select **Absoluta GSM** from the **Module** menu then press **Add**.
4. Select **Absoluta GSM** from **Account Settings**.
5. Type the IMEI number of the GSM Module in the **IMEI** option (the IMEI number is found on the Radio Module of the GSM Module, part **92** in Figure 6 on page 20 and can be displayed on LCD keypads as indicated in section "3.3) Display GSM Module Status" or the chapter "KEYPAD OPERATIONS").
6. Type the Installer PIN in the option **GS/IP Installer Code** (0104 at default).
7. Select **SMS** from the **Connection Type** menu, then press **Add**.
8. Select **SMS** from **Account Settings**.

9. Type the Telephone Number of the SIM card inserted in the GSM Module in the option **SMS Phone Number**, then press **Next**, then **Save**.
 10. Open the Customer Account and select Global Download , Global Upload , or Communicate Tags .
 11. Select **SMS** from the **Connection Type** menu, then press **OK**.
 12. Type the public IP address of the router to which the PC is connected in the option **Public IP Address** (ask the network administrator or see the router's instructions).
 13. Set *port forwarding* on the router of the **BOSS Port** to port **51004** of the IP address assigned to the PC (ask the network administrator or see the router's instructions).
 14. If this is the first time installed, press **APN Settings** and set the **APN Name**, **User Name**, and **Password** for GPRS services (ask the operator of the GPRS service).
-
-  *Make sure to type the correct APN for WAP/GPRS access - otherwise some functions may be limited.*
-
15. Press **OK** then send the message indicated by the **SMS Message Generator** to the GSM Module's number.







After receiving the SMS message, if correct, the Control Panel opens a remote connection via GPRS with the BOSS application: at this point, options can be downloaded/uploaded and the control panel can be managed through the **Status** page.



■ How Downloading/Uploading the Options

Once you have set up the connection, you can Downloading/Uploading the options as follow.

 **Downloading** is the operation that transfers data from PC to Control Panel.



Uploading is the operation that transfers data from Control Panel to PC.

1. Either select the options to Downloading/Uploading by enabling the relative Downloading /Uploading  Tabs or jump to the next step to Downloading/Uploading ALL the options (Global Downloading/Uploading):
 - the grey tag ( / ) means that the relative option neither will be uploaded nor downloaded;
 - the blue tag () means that the relative option will be **uploaded**;
 - the red tag () means that the relative option will be **downloaded**.

You can enable all the group options to be uploaded/downloaded by clicking on the  /  icon.

You can clear all the group option tags by clicking on the  icon on the Group toolbar.

You can clear option tags of all Groups by clicking on the  icon on the Main toolbar.

2. Either click on the  icon to start the Downloading/Uploading of the selected options or click on the  /  icon to Downloading/Uploading ALL the options.

 *The Global Downloading does not download Voice messages and PINs⁸.
The Global Uploading does not upload Voice messages, PINs⁸ and Event Log⁹.*

The application shows the **Communicate Tags** window.

3. Select the **Connection Type**.
4. Enter the **Access PIN** (default **0104**).
5. Set up the other options as required (refer to “Communication Tags Options”).
6. Click **OK**.

⁸ The PIN can be downloaded/uploaded if the user has enabled the “PIN transfer” option (see “Codes and Keys: User (PINs)”).

⁹ The Event Log can be uploaded from the **Event Log** page.

KEYPAD OPERATIONS

You can perform the following operation from any LCD keypad connected to the Control Panel, depending on your access level.

Operation	Installer Level	Level 4
View Alarms	Yes	Yes
Reset Alarms	Yes	
View Tamper	Yes	Yes
Reset Tamper	Yes	
View Faults	Yes	Yes
Reset Faults	Yes	
View Bypasses	Yes	Yes
View Partition Status	Yes	
View System Status	Yes	Yes
1.1) Zone Test	Yes	
1.2) Output Test	Yes	
1.3) Changing the PIN	Yes	Yes
1.4) Firmware Upgrade by an USB key		Yes
1.6) Modify the LCD Keypad language	Yes	
1.7) Enabling Level 4 access	Yes	
1.8) Clear Faults and Tamper	Yes	
1.9) Option Programming by Keypad	Yes	
2.1) Voice Message Recording	Yes	
2.2) BPI Device enrolling	Yes	
2.3) Wireless Device enrolling	Yes	
2.4) Key (card/tag) enrolling	Yes	
2.5) Message Download/Upload via USB Key	Yes	
2.6) Option Download/Upload via USB Key	Yes	
2.7) Factory Default	Yes	
2.8) Telephone Communicator	Yes	
2.9) Key Disabling/Enabling	Yes	
3.1) View Logger	Yes	
3.2) View the Firmware Version	Yes	Yes
3.3) View Zone Status and Zone Bypassing	Yes	
3.4) Display GSM Module Status	Yes	

 The number before the bracket is for the direct access to the relative option, as indicated forward.

 In this chapter we refer to the LCD Keypad: the operations on the Touchscreen Keypad are the same, unless otherwise indicated

You have the following two access levels.

- The **Installer Level** can perform all the operation listed on the previous table, except for the “Firmware Upgrade by an USB key”: the installer Level is dedicated to the installer of the system.
- The **Level 4** can only view the information about the system (alarms, tamper, faults, bypass, status and firmware version) and can perform the “Firmware Upgrade by an USB key”: the Level 4 is dedicated only to qualified people by the manufacturer.

 The **Installer Level** access must be enabled by the **user**, as indicated in the User Manual (OPERATING YOUR SYSTEM FROM A KEYPAD>Program>Enable Installer (Teleservice) (2.2)): enabled at default.

 The **Level 4** access must be enabled by the **installer** as indicated in “1.7) Enabling Level 4 access”: disabled at default.

Using the keypad

The following general rules for the keypad operations are valid unless otherwise stated.

- Press **ENTER** to confirm and go to the next step.
- Press **ESC** to abandon and go to the previous step.
- Press **a** and **b** to scroll the options.
- Press **c** and **d** to scroll the values.
- Press **ON** to enable an option.
- Press **OFF** to disable an option.

Access to the operations

LCD keypad

The display shows the data and time, and the message Bentel Absoluta¹⁰ on standby status.



1. Press **a** then enter the Installer PIN (**0104** at default) to access the **Installer Level** or press **b** and enter the Level 4 PIN (**0400** at default) to access the **Level 4**.

 *The Installer Level and the Level 4 access must be enabled as indicated in the previous page.*

2. Press **ENTER** and read the next paragraphs.

Wrong PIN The display shows the following message:



- if you do not enter the valid PIN before the **60 seconds** timeout expires;
- if you enter a wrong PIN.

NOT ALLOWED The display shows the following message:



If access to the Installer Menu of Level 4 has not been enabled.

TOUCH keypad

In standby, the screen on the Touch Keypad is turned off or shows the images selected for the digital photo frame.

1. Tap the screen:



2. Tap the screen again:



3. Tap .

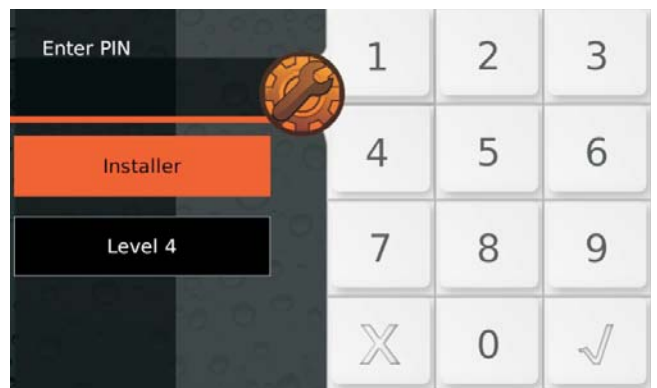

4. Select **Installer** to access the Installer Menu or **Level 4** to access the Level 4 Menu.
5. Enter the Installer PIN (**0140** at default) or PIN Level 4 (**0200** at default), then press  to confirm:



The screen displays a “Virtual keypad” like the one above.

6. Read the next paragraphs.

¹⁰ This is the default message. It can be changed by the option **System Options > General > LCD Keypad standby page**.

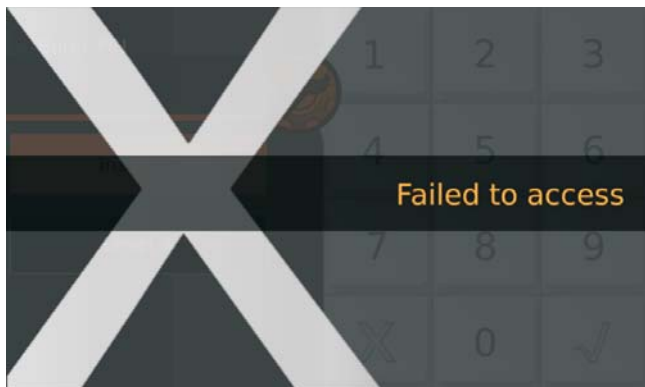

Failed to access The screen displays the following message:



- if you do not enter the valid PIN before the maximum time of **60 seconds**;
- If you enter an incorrect PIN;
- Access to the Installer menu or Level 4 has not been enabled.

View/Rest Alarms The keypad shows the Alarms if present:



- the  light ON indicates alarms in course;
 - the  light flashing indicates alarms in memory;
 - the display top line shows a flashing star (*) on the left if the alarm is not longer present (Alarm Memory), and the current alarm displayed respect to the total of alarms, on the right;
 - the display bottom line shows the label of the zone in alarm status.
7. Press **ENTER** to skip "View/Reset Tamper".
Press **A** to view the next alarm: if there are no more alarms to view, the display shows the next available events (tamper, faults or bypass) or the Partition and System status.
Press **OFF** to reset the alarms.

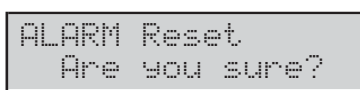

8. Press **ENTER** to confirm.



9. Press **ESC** to view the next event.

View/Reset Tamper The keypad shows the Tamper if present:

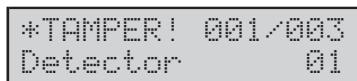
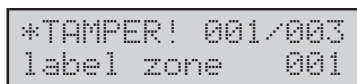

- the display top line shows a flashing star (*) on the left if the tamper is not longer present (Memory), and the current tamper displayed respect to the total of tamper, on the right;
- the display bottom line alternatively shows the label of the object in tamper status and the tamper cause.

10. Press **ENTER** to skip to "View/Reset Faults".

Press **A** to view the next tamper: if there are no more tamper to view, the display shows the next available events (faults or bypass) or the Partition and System status.

Press **OFF** to reset the tamper.



11. Press **ENTER** to confirm.



12. Press **ESC** to view the next event.

View Reset Faults The keypad shows the Faults if present:

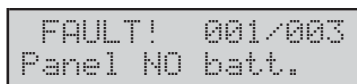

- the display top line shows the current fault displayed respect to the total of faults, on the right;
- the display bottom line shows the fault label.

13. Press **ENTER** to skip to "View Bypass".

Press **A** to view the next fault: if there are no more faults to view, the display shows the next available events (bypass) or the Partition and System status.
Press **OFF** to reset the faults.



14. Press **ENTER** to confirm.



15. Press **ESC** to view the next event.

View Bypass The keypad shows the Bypass if present:



- the display top line shows the current bypass displayed respect to the total of bypass, on the right;
- the display bottom line shows the label of the bypassed zone.

16. Press **ENTER** to skip to “View Partition and System status”.

Press **A** to view the next bypass: if there are no more bypasses to view, the display shows the Partition and System status.

View Partition and System status The display top line shows the date and time.

The display bottom line shows the state of the first 8 Partitions, on the left, as follow.

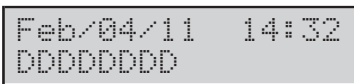

- **D**: Disarmed.
- **A**: Away Armed.
- **S**: Stay Armed.
- **I**: Instant Armed (Stay/Away with Zero Delay).
- **-**: Not assigned to the Keypad.

The following information on the right.

Icon	Signalled by	Description
	×	Control Panel Tamper (opened or wall removed)
	×	System Tamper (AS terminal)
	×	Peripheral Tamper (Keypad, Key Reader, Expander IN/OUT, Power Station, Wireless Receiver)
	×	False Key
	×	Peripheral Lost (Keypad, Key Reader, Expander IN/OUT, Power Station, Wireless Receiver)
	*	Installer Access enabled (locally and remotely)
	*	Answerphone facility enabled
		Telephone Line busy

17. Press **ENTER** to view the Option Menu.



18. Select the required option then go to the relative paragraph: you can either select the required option group by pressing the relative key then scroll to the required option by pressing the key **a** and **b**, or you can directly go to the required option by enter its address as indicated following.

- **1**: actions
 - **11**: Zone Test
 - **12**: Output Test
 - **13**: Changing the PIN
 - **14**: Firmware Upgrade by an USB key
 - **15**: Logger Downloading on a USB key
 - **16**: Modify the LCD Keypad language
 - **17**: Enabling Level 4 access
 - **18**: Clear Faults and Tamper
 - **19**: Option Programming by Keypad
- **2**: programming
 - **21**: Voice Message Recording
 - **22**: BPI Device enrolling
 - **23**: Wireless Device enrolling
 - **24**: Key (card/tag) enrolling
 - **25**: Message Download/Upload via USB Key
 - **26**: Option Download/Upload via USB Key
 - **27**: Factory Default
 - **28**: Telephone Communicator
 - **29**: Key Disabling/Enabling
- **3**: view
 - **31**: View Logger
 - **32**: View the Firmware Version
 - **33**: View Zone Status and Zone Bypassing
 - **34**: View GSM Module Status

Quit from the Operations

Press **ESC** until the display shows the following message (if you are on the Installer Level):



or the following message (if you are on the Level 4):

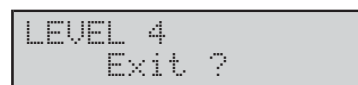

Press **ENTER** to confirm.

The keypad quit from the operations even when you do not press any key before the timeout expires: you have **30 seconds** timeout when the keypad is displaying information about the system (Alarms, Tamper, Faults, Bypass, Partitions and Status) and **180 seconds** when in the option menu.

1.1) Zone Test

This option will allow you to test all the partition zones without generating alarms. The Test event will be recorded in the event logger as: <Alarm - Zone under test>.

 *The Zone Test is possible only when the system is disarmed.*

1. Access the Installer menu, as indicated in the paragraph "Access to the operations".

```
INSTALLER
fact. 2Prq 3view
```

2. Select the **Action** option by pressing **1**.

```
INSTALLER      1.1
ZONE test
```

3. Select the **ZONE test** option, then press **ENTER**.

```
ZONE test
1=Beep_ 2=siren_
```

4. Select the Test Mode by pressing **1** and/or **2**.

- **1**: the alarm on zone will beep the keypads.
- **2**: the alarm on zone will sound the sirens.

Then press **ENTER**.

```
ZONE test
Part=- Zone --
```

5. Press **c** or **d** to select the zones to be tested:

- **Part=**, select ALL zones of the Partition (see step 6);
- **Zone=**, select a single Zone (see Step 7).

6. Select the Partition to test by pressing **a** or **b** to scroll the Partitions or by entering the relative ID number: the LCD top line shows the label of the selected Partition.

```
Label Part.  -01
Part=01 Zone --
```

7. Select the Zone to test by pressing **a** or **b** to scroll the zones or by entering the relative ID number: the Display top line shows the label of the selected Zone.

```
Label Zone   001
Part=- Zone 001
```

8. Press **ENTER** to confirm the Partition/Zone selected and go back to step 5 and add another partition or zone to be tested:

```
Label Part.  -01
In Test ON=Start
```

9. Press **ON** to start the Test:

```
Test on going
```

10. Perform the test on the selected zones:

- the keypad beeps, if enabled (refer to step 4);
- the siren sounds, if enabled (refer to step 4);
- the display upper line shows the tested zones respect to the zones to be tested;
- the display bottom line shows the label of the tested zone.

```
TEST!  001/008
Zone 001
```

11. Press **b** to view the lowest tested zone.

```
TEST!  008/008
Zone 001
```

12. Press **a** to scroll the tested zones.

```
TEST!  008/008
Zone 002
```

13. Press **d** to view the result of the test of the zone displayed on the line below the display:

an **x** indicates the tested status, as follow.

- **A**: Alarm
- **o**: Open
- **s**: Short circuit
- **T**: Tamper
- **F**: Fault
- **M**: Masking
- **B**: Battery Low

```
A o s T F M B
x - - - - -
```

Press **c** to go back to step 12 or press **ESC** to quit the Zone Test.

 *The Installer Menu Timeout is suspended during the Zone Test, giving you the time to perform the test. The keypad exits from the Installer Menu when you press **ESC** after the Installer Menu Timeout has expired.*

 *The tamper continues to work properly, during the test: information on the keypads, event logger, outputs and telephone actions.*

1.2) Output Test

This option will allow you to test the system Outputs.

1. Access the Installer menu, as indicated in the paragraph "Access to the operations".

```
INSTALLER
1act. 2prg 3view
```

2. Select the **Action** option by pressing **1**.

```
INSTALLER      1.1
ZONE test
```

3. Select the **OUTPUT test** option.

```
INSTALLER      1.2
OUTPUT test
```

4. Press **ENTER**.

```
On/Off Output -
```

5. Enter the ID Number relevant to the Software Output to be tested: the display bottom line shows the label of the selected output.

 *If the corresponding Output is active the second line blinks*

```
On/Off Output 01
Output 01
```

6. Press **ON** to activate the selected Output.

```
Output 01
  Activated
```

7. Press **OFF** to deactivate the selected Output.

```
Output 01
  Deactivated
```

8. Press **ON** to re-activate the selected Output or press **ESC** to select a different Output and go back to step 5.

1.3) Changing the PIN

This option will allow to you to change the Installer PIN or the Level 4 PIN, depending on the menu you are running (Installer Menu or Level 4 Menu): the default Installer PIN is **0104**; the default Level 4 PIN is **0400**.

 *You must press **A**, before enter the Installer PIN, to access the Installer Menu, and **B**, before enter the Level 4 PIN, to access the Level 4 Menu.*

You can change the PIN as follow.

1. Access the Installer menu or the Level 4 menu, as indicated in the paragraph "Access to the operations".

```
INSTALLER
1act. 2prg 3view
```

2. Select the **Action** option by pressing **1**.

```
INSTALLER      1.1
ZONE test
```

3. Select **Change My PIN**.

```
INSTALLER      1.3
Change my PIN
```

4. Press **ENTER**.

```
INSTALLER
New PIN
```

5. Enter the new Installer PIN, then press **ENTER**.

```
INSTALLER
Again
```

6. Enter again the new Installer PIN, then press **ENTER**:

- if the entries match, the new Installer PIN will be memorized and the Keypad go back to step 3,
- otherwise the Keypad will sound the error signal and go back to step 4.

1.4) Firmware Upgrade by an USB key

 To manage this operation it is necessary to enable the PIN of Level 4 (Default: **0400**).

You can upgrade the Control Panel Firmware as follow.

1. Download the required firmware from the Bentel website to the folder k_fw on an USB key.
2. Insert the USB key in the USB port 1 on the Control Panel (refer to the Figure 1 on page 11).

 The recognition of the USB key is possible **ONLY** if a USB cable is not connected to the PC.

3. Access the Level 4 menu, as indicated in the paragraph "Access to the operations".

```
LEVEL 4
1act. 2Pr9 3view
```

4. Select the **Action** option by pressing **1**.

```
LEVEL 4      1.3
Change my PIN
```

5. Select **USB->FW upgrade**.

```
LEVEL 4      1.4
USB->FW upgrade
```

6. Press **ENTER**.

```
Working
Wait Please
```

7. The Control Panel will restarts if the firmware upgrading succeeds otherwise the keypad display shows the following message.

```
USB operation
Failed
```

8. In this case press **ESC** to go back to the Installer Menu and repeat the operation after you have checked that:

- you have inserted the USB key in the USB port on the Control Panel;
- the used USB key is supported by the Control Panel (the Control Panel supports FAT32 formatting not NTFS);
- you have downloaded the firmware in the folder k_fw on the USB key;
- you have downloaded the correct firmware.

 You can view the current Control Panel Firmware as described in "View the Control Panel Firmware Revision" in this section.

 When you update the firmware from 1.60 to 2.00 version, wait for the second restart before attempt any operation.

1.6) Modify the LCD Keypad language

You can modify the LCD Keypad language as follow.

1. Access the Installer menu, as indicated in the paragraph "Access to the operations".

```
INSTALLER
1act. 2Pr9 3view
```

2. Select the **Action** option by pressing **1**.

```
INSTALLER      1.1
ZONE test
```

3. Select **Modify Lang.**

```
INSTALLER      1.6
Modify Lang.
```

4. Press **ENTER**: the Keypad display shows the available languages.

```
Modify Lang. 2/2
2=English
```

5. Select the required language by pressing the relative key: the language of the Keypad in use will change immediately.

1.7) Enabling Level 4 access

Level 4 is reserved to qualified personal to upgrade the Control Panel Firmware: Level 4 access is Disabled by default.

You can enable/disable the Level 4 access as follow.

1. Access the Installer menu, as indicated in the paragraph "Access to the operations".

```
INSTALLER
lact. 2prg 3view
```

2. Select the **Action** option by pressing 1.

```
INSTALLER      1.1
ZONE test
```

3. Select **Enable lev. 4.**

```
INSTALLER      1.7
ON/OFF level 4
```

4. Press **OFF** to disable Level 4 access (PIN) then press **ESC** to go back to the Installer Menu.

```
ON/OFF level 4
Disabled
```

5. Press **ON** to enable Level 4 access (PIN) then press **ESC** to go back to the Installer Menu.

```
ON/OFF level 4
Enabled
```

1.8) Clear Faults and Tampers

You can clear fault and tamper signalling as follow.

1. Access the Installer menu, as indicated in the paragraph "Access to the operations".

```
INSTALLER
lact. 2prg 3view
```

2. Select the **Action** option by pressing 1.

```
INSTALLER      1.1
ZONE test
```

3. Select **Clear Fault/Tamp.**

```
INSTALLER      1.8
Clear Fault/Tamp
```

4. Press **ENTER.**

```
Clear Fault/Tamp
1=Fau._ 2=Tam._
```

5. Select the action required by pressing the relative key.

- **1:** the Fault signalling will be cleared.
- **2:** the Tamper signalling will be cleared.

```
Clear Fault/Tamp
1=Fau.* 2=Tam.*
```

6. Press **ENTER** to perform the selected actions.

```
Clear Fault&Tamp
Are you sure?
```

7. Press **ENTER** again to confirm your choice or press **ESC** to go back to step 5.

```
Clear Fault&Tamp
Done !!
```

8. Press **ESC** to go back to step 3.

1.9) Option Programming by Keypad

You can programming the main Control Panel options by an LCD Keypad as follow.

1. Access the Installer menu, as indicated in the paragraph "Access to the operations".

```
INSTALLER
Inst. 2Pr9 3viev
```

2. Select the **Action** option by pressing **1**.

```
INSTALLER      1.1
ZONE test
```

3. Select **Panel Prog.**

```
INSTALLER      1.9
Panel Prog.
```

4. Press **ENTER**.

```
Panel Prog.
Zones      Zn--
```

5. Select the Option Group you want set up by pressing **a** and **b** then press **ENTER** and refer to the relative paragraph.

 *The Installer Menu Timeout is suspended during the Option Programming. The keypad exits from the Installer Menu when you press **ESC** after the Installer Menu Timeout has expired.*

■ Zones

```
Panel Prog.
Zones      Zn--
```

The **Zone** option let you to set up the Zone Partitions as follow.

1. Enter the Identification Number of the Zone you want set up.

```
Panel Prog.
Zones      Zn001
```

2. Press **ENTER**.

```
Zones      Zn001
Part mask
```

3. Press **ENTER** again: the characters on the display bottom line show the Partitions of the selected zone: the 1st is for Partition 1, the 2nd is for Partition 2 and so on, as follow.

- *: the Zone is assigned to the Partition.
- -: the Zone is NOT assigned to the Partition.

```
Part mask Zn001
*-----*
```

4. Set up the Zone Partitions as follow.
 - Press **a** to assign ALL the Partitions to the Zone.
 - Press **b** to assign none Partition to the zone.
 - Press **c** and **d** to scroll the Partitions: a blinking character indicates the currently selected Partition.
 - Press **ON** to assign the selected Partition to the Zone.
 - Press **OFF** to NOT assign the selected Partition to the Zone.
 - Press **ENTER** to confirm the Zone Partitions or **ESC** to discharge the changes, and go back to step 1.

```
Part mask Zn001
*-----*
```

In the top example, Zone 1 is assigned to the Partitions 1 and 16.

■ Partition

```
Panel Prog.
Partition Pt--
```

The **Partition** option let you to set up the Entry and Exit Times for the Partitions, as follow. Enter the Identification Number of the Zone you want set up.

1. Enter the Identification Number of the Partition you want set up.

```
Panel Prog.
Partition Pt001
```

2. Press **ENTER**.

```
Partition Pt001
Entry time
```

3. Press **a** and **b** to scroll the **Entry time** and **Exit time**, then press **ENTER** to select the displayed option: the display bottom line shows the current value on the left, and the valid range on the right.

```
Entry time Pt001
30s : 15/3600
```

4. Enter the required value.
 - You must enter a 4-digit value: e.g. you must press 0, 0, 6 and 0 to enter 60 seconds.
 - Press **ESC** to delete the value.
 - Press **ESC** again to to discharge the changes and go back to step 3.
 - Press **ENTER** to confirm the value and go back to step 3.

■ User PINs

```
Panel Prog.  
User PINs UC--
```

The **User PINs** option let you to set up the PIN Partitions as follow.

1. Enter the Identification Number of the User PIN you want set up.

```
Panel Prog.  
User PINs UC001
```

2. Press **ENTER**.

```
User PINs UC001  
Part mask
```

3. Press **ENTER** again: the characters on the display bottom line show the Partitions of the selected User PIN : the 1st is for Partition 1, the 2nd is for Partition 2 and so on, as follow.

- *: the User PIN is assigned to the Partition.
- -: the User PIN is NOT assigned to the Partition.

```
Part mask UC001  
*****
```

4. Set up the User PIN Partitions as described for the zones.
 - In the top example, User PIN 1 is assigned to the Partitions 1 and 16.

■ Keys

```
Panel Prog.  
Keys K--
```

The **Keys** option let you to set up the Keys Partitions as described for the zones.

■ WLS Keys

```
Panel Prog.  
WLS keys WK--
```

The **WLS Keys** option let you to set up the Wireless Keys Partitions as described for the zones.

■ System

```
Panel Prog.  
System
```

The **System** option is for setting the Control Panel ID Number, as follows.

Press **ENTER**:

```
System  
Panel ID
```

Press **ENTER** again: the display shows the current ID number in the bottom left:

```
System  
0000 : 0/9999
```

Enter the ID number of the Control Panel (0 to 9999) and then press **ENTER** to confirm or **ESC** to cancel and go back in step 1.

■ Key Reader

```
Panel Prog.  
Key Reader KR--
```

The **Key Reader** option is for setting the Reader Partitions, as described for zones.

■ Keypad

```
Panel Prog.  
KeyPad KP--
```

The **Keypad** option is for setting the Keypad Partitions, as described for the zones.

2.1) Voice Message Recording

You can recording and playback the Voice Messages by means the Audio Station **AS100**, as follow.

1. Access the Installer menu, as indicated in the paragraph "Access to the operations".

```
INSTALLER
lact. 2Pr9 3view
```

2. Select the **Programming** option by pressing **2**.

```
INSTALLER 2.1
Voice Messages
```

3. Select **Voice Messages**.

```
INSTALLER 2.1
Voice Messages
```

4. Press **ENTER**.

```
Message Num. ---
```

5. Enter the ID number of the Voice Message to record/playback, then press **ENTER**. The display upper line show the selected message on the right its status on the left:

- **Free**: the Message is empty;
- **Used**: the Message is already used.

```
M001 Free
1=> 2=Rec 3=Stop
```

6. Press **1** to play the message. Press **3** to stop the playback. A bar on the display upper line shows the play progress.

- *: the play time.
- =: the Message length.
- -: the free space.

```
M001 play *==---
1=> 2=Rec 3=Stop
```

7. Press **2** to record a new message. Press **3** to stop the recording. A bar on the display upper line shows the recording progress.

- *: the recording time.
- =: the free space.

```
M001 rec. *====
1=> 2=Rec 3=Stop
```

2.2) BPI Device enrolling

You can perform the BPI Device enrolling when you change the BPI bus configuration, as follow.

1. Access the Installer menu, as indicated in the paragraph "Access to the operations".

```
INSTALLER
lact. 2Pr9 3view
```

2. Select the **Programming** option by pressing **2**.

```
INSTALLER 2.1
Voice Messages
```

3. Select **BPI Enroll**.

```
INSTALLER 2.2
BPI Enroll
```

4. Press **ENTER**. The Control Panel takes a few second to check the devices on the BPI bus:

- the display shows the following message if the BPI bus configuration matches with the currently in the Control Panel memory.

```
Devices match
ESC or ENT=modif
```

- Otherwise, the display shows the new BPI bus configuration.

```
Kb=01 Kr=01 A1=0
Ei=01 Eo=01 OK?
```

5. Press **ENTER** to modify the configuration (refer to "Auto-configuration (Wizard setup)" in the "INSTALLING" section for more details) or **ESC** to quit.

 *If you made any changes, simply press OFF to make a new configuration, without having to repeat the procedure from the beginning.*

2.3) Wireless Device enrolling

You can enroll the Wireless Devices and perform the Placement Test as follow.

1. Access the Installer menu, as indicated in the paragraph "Access to the operations".

```
INSTALLER
1act. 2prg 3view
```

2. Select the **Programming** option by pressing **2**.

```
INSTALLER 2.1
Voice Messages
```

3. Select **WIRELESS Config.**

```
INSTALLER 2.3
WIRELESS Config.
```

4. Press **ENTER**.

```
WIRELESS Config.
1=Zn 2=K 3=Test
```

5. Press **1** to enroll Wireless Detectors, **2** to enroll Wireless Keys, **3** to perform the Placement Test, the refer to the relative paragraph below.

Wireless Detector

```
WIRELESS Config.
Zone 013
```

6. Select the required Position (Zone/Slot) for the Wireless Detector, then press **ENTER**.

 *The display prompts the first free Software Zone.*

```
note:ON=E, OFF=F
ESN ----
```

7. Enter the 6-digit Electronic Serial Number you can find on the Wireless Detector (refer to the Detector's instructions for more details):
 - use the cursors keys **a**, **b**, **c**, and **d** to enter respectively the digits A, B, C and D;
 - press **ON** to enter E;
 - press **OFF** to enter F.

```
note:ON=E, OFF=F
ESN 299AFC
```

8. Press **ENTER**.

```
WLS zone type
1=int. 2=delay
```

9. Set up the Wireless Zone Type, then press **ENTER** and go back to step **5**.
 - **1**:Internal.
 - **2**: Delayed.

Wireless Keys

```
WIRELESS Config.
Key 001
```

10. Select the required Position (Slot) for the Wireless Key, then press **ENTER**.

```
note:ON=E, OFF=F
ESN ----
```

11. Enter the 6-digit Electronic Serial Number you can find on the Wireless Key, as per the Wireless Detectors.

```
note:ON=E, OFF=F
ESN 6989E2
```

12. Press **ENTER** and go back to step **5**.Wireless Detector

Placement Test

```
WLS Placem. Test
Zone 013
```

13. Select the (Detector) Wireless Zone to test, then press **ENTER**.

 *The display prompts the first Wireless Zone of the System.*

```
Result .....
```

14. Perform the Placement Test as indicated in the Detector's instructions.

```
Result .....
GOOD!!
```

- If the result is **GOOD**, you can mount the detector in the selected placement: press **ESC** and go back to step **13**.

```
Result .....
BAD!!
```

- If the result is **BAD**, you must move the Detector in a different position and try again: press **ESC** and go back to step **13**.

2.4) Key enrolling

You can enroll the Digital Keys as follow.

1. Access the Installer menu, as indicated in the paragraph "Access to the operations".

```
INSTALLER
lact. 2Pr9 3view
```

2. Select the **Programming** option by pressing **2**.

```
INSTALLER 2.1
Voice Messages
```

3. Select **Key programming**.

```
INSTALLER 2.4
Key Programming
```

4. Press **ENTER**.

```
Key Programming
on Reader ---
```

5. Select the Key Reader to enroll the Keys, then press **ENTER**.

```
Key Programming
Key ---
```

6. Select the Key slot, then press **ENTER**: ALL the selected Key Reader's LEDs fast blinking to indicate that it is waiting for a Key.

 if the display shows the message **Key active**, the selected slot is already used by a Key. Press **ESC** and select a free slot or press **ENTER** to overwrite the position with the new Key.

```
Key Programming
Wait for key
```

7. Present the Key to the selected Key Reader: the **green** indicator light and the Keypad sounds a double beep to indicate that the Key has been enrolled and go back to step **6**.

 if the display shows the message **Key used**, the **yellow** indicator on the Reader blinks quickly and the Keypad sounds a single beep, the key is already enrolled on a different slot. Press **ESC** and go back to step **6**.

2.5) Message Download/Upload via USB Key

You can use a USB key to transfer the Voice Messages from the PC to the Control Panel and vice versa, and from a Control Panel to another, as follow.

1. Insert an USB key in the USB port **1** on the Control Panel (refer to the Figure 1 on page 13).
2. Access the Installer menu, as indicated in the paragraph "Access to the operations".

```
INSTALLER
lact. 2Pr9 3view
```

3. Select the **Programming** option by pressing **2**.

```
INSTALLER 2.1
Voice Messages
```

4. Select **USB <-> AUDIO**.

```
INSTALLER 2.5
USB <-> AUDIO
```

5. Press **ENTER**.

```
USB <-> AUDIO
Load from USB?
```

6. Select **Load from USB** to transfer the Voice Messages from the USB Key to Control Panel. Select **Save in USB** to transfer the Voice Messages from the Control Panel to the USB Key. Then Press **ENTER**.

```
Working
Wait Please
```

7. The Keypad display will show the following message if the operation succeeds: press **ESC** to go back to the Installer Menu.

```
USB operation
Done !!
```

8. The Keypad display will show the following message if the operation fails.

```
USB operation
Failed
```

9. Press **ESC** to go back to the Installer Menu and repeat the operation after you have checked that:
 - the Installer PIN entered is the same as the one used for recording voice messages (see "Voice Messages Recording");
 - you have inserted the USB key in the USB port on the Control Panel;
 - the used USB key is supported by the Control Panel (the Control Panel supports FAT32 formatting not NTFS);
 - you have enough space free on the USB key;
 - you have downloaded Voice Messages on the USB key.

2.6) Option Download/Upload via USB Key

Using a USB key you can Download/Upload the Options between PC and Control Panel, and between different Control Panels, as follow.

☞ *The Installer PIN of the Panel/BOSS that has generated the option file must match with the Installer PIN of the Panel/BOSS that loads the file option.*

☞ *It is possible to Download/Upload the options ONLY between control panels of the same version.*

1. Insert an USB key in the USB port **1** on the Control Panel (refer to the Figure 1 on page 13).
2. Access the Installer menu, as indicated in the paragraph "Access to the operations".
3. Select the **Programming** option by pressing **2**.

```
INSTALLER 2.1
Voice Messages
```

4. Select **USB <-> AUDIO**.

```
INSTALLER 2.6
USB <-> PROG
```

5. Press **ENTER**.

```
USB <-> PROG
Load from USB?
```

6. Select **Load from USB** to upload the Options from the USB Key to Control Panel. Select **Save in USB** to transfer the Options from the Control Panel to USB Key. Then Press **ENTER**.

```
Working
Wait Please
```

7. The Keypad display will show the following message if the operation succeeds: press **ESC** to go back to the Installer Menu.

```
USB operation
Done !!
```

8. The Keypad display will show the following message if the operation fails.

```
USB operation
Failed
```

9. Press **ESC** to go back to the Installer Menu and repeat the operation after you have checked that:
 - you have inserted the USB key in the USB port on the Control Panel;
 - the used USB key is supported by the Control Panel (the Control Panel supports FAT32 formatting not NTFS);
 - you have enough space free on the USB key;
 - you have downloaded the Options on the USB key.

2.7) Factory Default

You can restore the control Panel Options to factory default as follow.

☞ *You can also perform the Factory Default by hardware, as indicated on "Hardware Default" in the "INSTALLING" section.*

☞ *To restore the Voice Messages, download the audio file from the BENTEL website onto a USB key, then upload the Voice Messages from the USB key to the control panel as described in section "2.5) Message Download/Upload via USB Key".*

1. Access the Installer menu, as indicated in the paragraph "Access to the operations".

```
INSTALLER
fact. 2=prg 3=view
```

2. Select the **Programming** option by pressing **2**.

```
INSTALLER 2.1
Voice Messages
```

3. Select **Factory default**.

```
INSTALLER 2.7
Factory default
```

4. Press **ENTER**.

```
Factory default
1=all 2=PIN 3=PR
```

5. Select the required option by pressing the relative key.
 - **1**: will restore ALL the options to the factory default, EXCEPT FOR the Voice Messages.
 - **2**: will restore ONLY the PINs and the enrolled Keys to the factory default.
 - **3**: will restore ALL the Options, including the Wireless Keys, EXCEPT the PINs, the enrolled Keys and the Voice Message to the factory default.
6. Press **ENTER**: the display will show one of the following messages depending on the selected option.

```
All Parameters
Are you sure?
```

```
Only PINs
Are you sure?
```

```
Only Programming
Are you sure?
```

7. Press **ENTER** again to perform the selected option: the System will restart from the Start up menu, if you have choice the option 1 and 3, or from Stand by status if you have choice the option 2.

2.8) Telephone Communicator

You can set up the PSTN Communicator options as follow.

1. Access the Installer menu, as indicated in the paragraph "Access to the operations".

```
INSTALLER
lact. 2Pr9 3view
```

2. Select the **Programming** option by pressing **2**.

```
INSTALLER 2.1
Voice Messages
```

3. Select **PSTN communic.** then press **ENTER**.

```
note:ON=E, OFF=F
Account Cod.--
```

4. Enter the required Account Code then press **ENTER**: you can assign different Account Codes for each telephone number; the Account Code you enter on this step will be assigned to all Telephone Numbers set by following; to assign a different Account Code, go back to this step.

```
TEL commun.
Trum.--
```

5. Enter the required Telephone Number ID then press **ENTER**: the display bottom line shows the Type and Reporting Format on the right, as follow.

- **Voc**: Vocal Telephone Number.
- **Dig**: Digital Telephone Number.
- **CID**: Contact ID Reporting Format.
- **SIA**: SIA Reporting Format

```
TEL commun.
Trum.01 Voc
```

6. Select the Telephone Number Type by pressing **a** and **b**, then press **ENTER** and go back to step **5** if you have choose the Vocal Type or go to the next step if you have choose the Digital Type.

```
TEL commun.
Trum.01 Di9 CID
```

7. Select the Telephone Number Reporting Format by pressing **a** and **b**, then press **ENTER**.

```
TEL commun.
>
```

8. Enter the required Telephone Number:

- press **a** to insert a 4 second pause;
- press **d** to insert a 2 second pause;
- press **c** to cancel the last digit;
- press **ENTER** to confirm and go back to step **5**.

2.9) Key Disabling/Enabling

You can enable/disable the keys (cards/tags/wireless keys) as follow.

1. Access the Installer menu, as indicated in the paragraph "Access to the operations".

```
INSTALLER
lact. 2Pr9 3view
```

2. Select the **Programming** option by pressing **2**.

```
INSTALLER 2.1
Voice Messages
```

3. Select **Dis/Ena.key**.

```
INSTALLER 2.9
Dis/Ena.key
```

4. Press **ENTER**.

```
Key
1=ULS 2=BPI
```

5. Press **1** to disable/enable a Wireless Key or **2** to disable/enable a BPI Key (Card/Tag).

```
Key -----
```

6. Enter the ID number of the Key to disable/enable: the display bottom line shows the relative label.

```
Key 001
Label key 001
```

7. Press **OFF** to disable the Key.

```
Label key 001
Disabled
```

8. Press **ON** to enable the Key.

```
Label key 001
Enabled
```

9. Press **ESC** to confirm and go back to step **6**.

3.1) View Logger

You can view the event in the logger as follow.

1. Access the Installer menu, as indicated in the paragraph "Access to the operations".

```
INSTALLER
1act. 2prg 3view
```

2. Select the **View** option by pressing **3**.

```
INSTALLER      3.1
View LOG
```

3. Select **View LOG**.

```
INSTALLER      3.1
View LOG
```

4. Press **ENTER**.

```
View LOG
1=Last 2=since..
```

5. Press **1** to view the events from the last or **2** to view the events from a specific date and time, then press **ENTER**.

```
Data/Time
mm/dd/yy hh:mm
```

6. Skip to the next step if you have chose the option **1**, otherwise enter the required Data and Time to start to view the events, then press **ENTER**:

- the display top line shows the order number of the event;
- the display bottom line shows the event description.

```
EV.0125
User entry
```

7. Press **a** and **b** to scroll the events. Press **c** and **d** to scroll the details of the event.

```
EV.0125      WHO
INSTALLER
```

8. The display top line shows the detail name on the right, as follow.

- **WHO**: depending on the event, the Zone, the Key (Card/Tag), the Wireless Key or the Super Key that had generated the event.
- **WHERE**: depending on the event, the Wireless Receiver, the RS232 port, the USB port, the Telephone Line, the System, the Panel, the Keypad, the Key reader, the Expander In, the Main Board, the Expander Out or the Power Station where the event occurred.
- **PARTIT.**: depending on the event, the involved Partitions.
- **WHEN**: the date and time when the event has occurred.

3.2) View the Firmware Version

You can view the version of the Control Panel Firmware as follow.

1. Access the Installer menu or the Level 4 menu, as indicated in the paragraph "Access to the operations".

```
INSTALLER
1act. 2prg 3view
```

2. Select the **View** option by pressing **3**.

```
INSTALLER      3.1
View LOG
```

3. Select **Firmware Version**.

```
INSTALLER      3.2
Firmware version
```

4. Press **ENTER**.

```
ABS FW 03.00.15
Z=104 sn000000000
```

The display shows the following information.

- **ABS FW 03.00.15**: the Firmware Version.
- **Z=104**: the ABS-104 Main Board model.
- **Z=042**: the ABS-42 Main Board model.
- **Z=016**: the ABS-16 Main Board model.
- **sn000000000**: the Serial Number.

5. Press **c** or **d** to view the firmware version of the GSM module (if installed):

```
GSM FW 02.00.10
```

3.3) View Zone Status and Zone Bypassing

You can view the zone status (standby, alarm, tamper, short-circuit, bypassed, included) and bypass the zones as follow.

1. Access the Installer menu, as indicated in the paragraph "Access to the operations".

```
INSTALLER
lact. 2Frg 3view
```

2. Select the **View** option by pressing **3**.

```
INSTALLER 3.1
View LOG
```

3. Select **Zone status**.

```
INSTALLER 3.3
Zone status
```

4. Press **ENTER**.

```
Zone status --
```

5. Select the required zone by entering its ID number or scrolling by pressing **a** and **b**: the display bottom line shows the label of the selected zone.

```
Zone status 001
label zone 001
```

6. Press **ENTER**: the display bottom line shows the zone status as follow.

- **ST_BY**: the zone is in standby.
- **ACTIVE**: the zone is active.
- **OPEN**: the zone is open (tampered).
- **SHORT**: the zone is short-circuited.
- **WORKING**: the zone is operative (included).
- **BY-PASS**: the zone is bypassed.

```
label zone 001
ST-BY WORKING
```

7. Press:

- **OFF** to bypass the zone,

```
label zone 001
Bypassed now
```

then press **ESC** to go back to step 5;

- **ON** to include the zone,

```
label zone 001
Included
```

then press **ESC** to go back to step 5;

- **d** to view the zone details,

```
label zone 001
Board T1 D
```

Board: the zone is on the Main Board.

Wired Ein01: the zone is on the Expander In 01.

WLS: the Zone is Wireless.

ESN: the Zone Electronic Serial Number.

T1: the Zone Terminal Board.

O: the Zone is Normally Open.

C: the Zone is Normally Closed.

S: the Zone is SEOL Supervised.

D: the Zone is DEOL Supervised.

3.4) View GSM Module Status

The status of the GSM Module can be viewed as described below.

1. Access the Installer menu, as indicated in the paragraph "Access to the operations".

```
INSTALLER
1act. 2prg 3view
```

2. Select the **View** option by pressing **3**.

```
INSTALLER      3.1
View LOG
```

3. Select **GSM Status**.

```
INSTALLER      3.4
GSM Status
```

4. Press **ENTER**.

```
GSM OK! ^!***
VODAFONE
```

The display shows:

- **GSM OK**, the GSM Module is working normally;
 - **Link Lost**, network problem, no SIM;
 - **Fault**, GSM Module problem;
 - **Wrong Firmware**, the firmware is not compatible with the Control Panel;
 - **^*****, the GSM signal strength (no asterisk, no signal; three asterisks (***) , excellent signal, mean excellent GSM signal strength);
 - **VODAFONE**, operator name.
5. If the status of the GSM Module is OK, press **ENTER** to show the telephone number of the SIM card inserted in the GSM Module:

```
ABSOLUTA GSM num
+39328456789
```

☞ *The number shown by the display is the one entered in the option **SIM Phone Number** from the **GSM** option group. If NO number has been entered, the display will show NO NUMBER.*

6. Press **ENTER** to show the IMEI number of the GSM Module:

```
IMEI:
1234567890123456
```

7. Press **ENTER** to show the number of the SIM card inserted in the GSM Module:

```
SIM num.: 12345
1234567890123456
```

8. Press **ENTER** to show the status of the GPRS connection on the display top line and the IP address on the bottom line:

```
GPRS OK!
127.0.0.1
```

9. Press **ENTER** to check the remaining credit:

```
Pay AsYouGo Bal.
Are You Sure?
```

10. Press **ENTER** to confirm and the control panel will send an SMS to check the credit remaining:

```
Pay AsYouGo Bal.
Please Wait
```

☞ *The **Pay As You Go Options** of the **GSM** group must be set correctly, otherwise the display will display message Failed.*

11. When the control panel receives the message with the credit information, the display shows SMS x/n, where x is the number of the message shown and n is the number of messages received, an asterisk (*) if the message has not been read yet and, on the row below, the number that the message has sent:

```
SMS 01/01* From
404
```

12. Press **ENTER** to display the date and time of receipt of the message:

```
SMS 01/01* Time
Mar/09/13 16:32
```

13. Press **ENTER** to display the text of the message: the message begins to scroll automatically to the bottom line of the display.

```
SMS 01/01 Text
Your balance is
```

14. Press:

- **c** to lock the automatic scrolling and scroll the message manually to the left;
- **d** to scroll the message manually to the right;
- **ON** to reactivate the automatic scrolling of the message automatically from left to right.

15. Press **OFF** to delete the message:

```
SMS 01/01 Text
Delete SMS?
```

16. Press **ENTER** to confirm and return to step 11 or **ESC** to cancel and return to step 13.

Installer Menu (Default PIN: A0104)					
1 actions		2 programming		3 visualization	
1.1	Zone Test	2.1	Voice Messages	3.1	Logger
1.2	Output Test	2.2	BPI Device Enroll	3.2	Firmware Version
1.3	Change my PIN	2.3	Wireless Device Enroll	3.3	Zone Status and Zone Bypassing
		2.4	Key Enroll	3.4	GSM Module Status
		2.5	Voice Message via USB Key		
1.6	Modify Language	2.6	Options via USB Key		
1.7	Enable Level 4 Access	2.7	Factory Default		
1.8	Clear Fault/Tampers	2.8	PSTN Communicator		
1.9	Option Programming by Keypad	2.9	Disable/Enable Key		

Level 4 Menu (Default PIN: B0400)					
1 actions				3 visualization	
1.3	Change my PIN			3.2	Firmware version
1.4	Firmware Upgrade by USB key				

Master User Menu (Default PIN: 0001)					
1 actions		2 programming		3 visualization	
1.1	Alarm Reset	2.1	ON/OFF Answering	3.1	View LOG
1.2	Extra Time Request	2.2	ON/OFF Installer	3.2	Zone Status
1.3	Clear Call Queue	2.3	ON/OFF Auto-arming	3.3	GSM Module Status
1.4	Teleservice Request	2.4	Date/Time	3.4	Incoming SMS
1.5	Alarm Signals Test	2.5	PIN Programming		
1.6	Outputs (ON/OFF)	2.6	Telephone Numbers	3.6	ABSOLUTA INFO
1.7	Arm Partition	2.7	Change my PIN		
1.8	Zone Test	2.8	Zone Bypassed		
1.9	Clear Fault/Tamper	2.9	Disable/Enable Key		

Normal User Menu					
1 actions		2 programming		3 visualization	
1.1	Alarm Reset			3.1	View LOG
1.2	Extra Time Request			3.2	Zone Status
1.3	Clear Call Queue			3.3	GSM Module Status
				3.4	Incoming SMS
1.5	Alarm Signals Test				
1.6	Outputs (ON/OFF)				
		2.7	Change my PIN		

Limited User Menu					
1 actions				3 visualization	
1.1	Alarm Reset			3.1	View LOG
				3.2	Zone Status
1.3	Clear Call Queue				

Table 17 Quick guide for the LCD Keypad menu.

Quick guide for the LCD Keypad menu

The Table 17 on facing page, list the options available for each menu that you may access on the LCD Keypad.

Zone Automapping

On The ABSOLUTA series Control Panels the relationship between the physical input zones position (on Main Board, BPI Input Expanders or Wireless) and the zones position really managed by the panel (following named *Logical Zones*) is not fixed.

This feature requires that each valid Physical Zone has to be assigned to one Logical Zone before to become functional: this process is named *Zone Mapping*.

The zone mapping may be accomplished manually via BOSS control software but it is also performed automatically every time you perform the Wizard Setup (refer to "Auto-Configuration (Wizard setup)" in the "INSTALLING" section), as indicated below.

1. The Control Panel searches the first Physical Zone with a Standby Status and Supervision DIFFERENT from *not used* (that is, the zones that are NOT indicated by a dash).
2. If a Physical Zone is available to be mapped, goes to the next step, else it quits the procedure.
3. The Control Panel searches the first available Logical Zone position tagged as *free*, skipping all the positions that result as occupied.
4. If there is a free Logical Zone position goes to the next step, else it quits the procedure.
5. The Control Panel maps the Physical Zone to the free Logical Zone position.

This sequence will be repeated until there are Physical Zones available to be mapped or Logical Zone positions free.

At the end of the wired zones auto-mapping procedure all the mapped zones become functional.

Two main scenarios may be considered.

- ❑ The auto-mapping process runs on a completely cleared zone's map (first panel power-on or BPI enrol after a full factory default). In this case:
 - the available Physical Zones will be mapped sequentially starting from the first Logical Zone position.
- ❑ The auto mapping process runs on a written zone's map (BPI enrol on an already configured system). In this case:
 - the Physical Zones that are still present, maintain their Logical Zone position;
 - the Physical Zones that are no longer present, if any, will free their Logical Zone position;
 - the new physical zones, if any, will be mapped in all the free Logical Zone positions available.

 *The Wireless Zones mapping is under control of the installer: the Control Panel simply suggests, at each Wireless zone enrolling, what is the first Logical Zone position free.*

Reporting Formats

This paragraph describes the structures of the main reporting formats supported by the system.

☞ *Installer should customize codes for Superkey according to customer (f.e. 1: Emergency, 2: Fire, 3: Alarm). 000 means NO Communicate.*

■ Contact ID

Contact ID transmits as follows.

- **User Code** (4 hexadecimal digits — 0 through F).
- **Qualifier:** **1** = new event or Disarming operation; **3** restore event or Arming operation.
- **Class Code (CL. column):** identifies the type of event (Alarm, Trouble, Fire, etc.).
- **Reporting Code (CODE column):** identifies the event (Reporting Codes can be changed, refer to “Events and Actions” in the “PROGRAMMING FROM THE PC” section).

☞ *00 means NO communication.*

- **Group Number (GROUP column),** where possible, identifies the Partition of the “resource” which generated the event.
- **Zone Number (ZONE column),** where possible, identifies the “resource” (Zone, Code, Key, etc.) which generated the event.

■ SIA

SIA is a FSK (Frequency Shift Keying) format, that transmits alternatively in two slightly different frequencies. The frequency shift is usually 170 Hertz, and the two frequencies are associated with 0 and 1 of the binary digit which transmits the following data:

- **User Code** (4 digits — 0 through 9)
- **Function Code** (1 digit; N=new event, O=restore event)
- **Date** (month-day-year)
- **Time** (hour-minutes-seconds)
- **Event Type** (refer to the **TYPE** column in Table 18)
- **Event Agent** (refer to the **1st** and **2nd** columns in Table 18).

EVENT	CONTACT ID			SIA			
	CL.	CODE	GROUP	ZONE	TYPE	1 st	2 nd
Alarm on zone	1	30	00	Zone n.	BA/BR	0000	Zone n.
Tamper on zone	1	37	00	Zone n.	TA/TR	0000	Zone n.
Fire alarm on partition	1	10	Part. n.	000	FA/FH	Part. n.	000
Device low battery	3	84	00	000	XT/XR	0000	Zone n.
Partial arming partition	4	41	Part. n.	11	NL/OP	part. n.	11
Generic alarm on partition	1	30	Part. n.	000	BA/BH	part. n.	000
Tamper alarm on partition	1	37	Part. n.	000	TA/TR	part. n.	000
Global arming partition	4	00	Part. n.	11	CL/OP	part. n.	11
Disarming partition	4	00	Part. n.	11	OP/CL	part. n.	11
keyfob low battery	3	38	00	Keyfob n.	XT/XR	0000	Keyfob n.
Tamper on Main unit	1	37	00	000	TA/TR	0000	000
Service jumper	0	00	00	000	00/00	0000	000
Tamper on external siren	1	37	00	000	TA/TR	0000	000
Tamper on internal siren	1	37	00	000	TA/TR	0000	000
Tamper on Main unit (seize)	1	37	00	000	TA/TR	0000	000
Warning BPI peripheral	3	33	00	000	EM/EN	0000	000
Balanced tamper	1	37	00	000	TA/TR	0000	000
Warning fuse	3	00	00	000	YP/YQ	0000	000
Tamper BPI device	1	45	00	000	ES/EJ	0000	000
Schedule on Partition	0	00	00	000	00/00	0000	000
Wireless zone loss on Panel	3	81	00	000	BS/BR	0000	000
Wireless Receiver Tamper	1	45	00	000	ES/EJ	0000	000
Zone alarm on Panel	1	30	00	000	BA/BH	0000	000
Zone tamper on Panel	1	37	00	000	TA/TR	0000	000

Table 18 Structure of the main Reporting formats supported by the System (continued ...).

11Transmits: **000** for the operation performed by the Command Zones and the Scheduler; the Identification Number of the PIN which produced the event (from **001** to **128**); the Identification Number, increased by **128** units, of the Digital Key which produced the event (from **129** to **378**); the Identification Number, increased by **128 + 250** units, of the Wireless Key which produced the event (from **379** to **394**). For example, if the event was produced by PIN no.1, 001 is transmitted; if the event was produced by Digital Key no.1, 129 (1 + 128) is transmitted.

EVENT	CONTACT ID				TYPE	SIA	
	CL.	CODE	GROUP	ZONE		1 st	2 nd
System fault	3	00	00	000	BT/BJ	0000	000
Real time zone on Panel	0	00	00	000	00/00	0000	000
Zone bypass on Panel	5	70	00	000	BB/BU	0000	000
WLS receiver lost	3	33	00	000	EM/EN	0000	000
Partition alarm on Panel	1	30	00	000	BA/BH	0000	000
Partition tamper on Panel	1	37	00	000	TA/TR	0000	000
Partial arming on Panel	4	41	00	000	NL/OP	0000	000
Global arming on Panel	4	00	00	000	CL/OP	0000	000
Exit time on Partition	0	00	00	000	00/00	0000	000
Entry time on Partition	0	00	00	000	00/00	0000	000
Autoarming warning Partition	0	00	00	000	00/00	0000	000
Memory alarm on Panel	1	30	00	000	BA/BH	0000	000
Alarm stop on Panel	0	00	00	000	00/00	0000	000
Panel fault	3	00	00	000	BT/BJ	0000	000
Warning mains failure	3	01	00	000	AT/AR	0000	000
Warning low battery	3	02	00	000	YT/YR	0000	000
Battery power trouble	3	09	00	000	YM/YQ	0000	000
Warning mains failure on Power station	3	01	00	000	AT/AR	0000	000
Warning low battery on Power station	3	02	00	000	YT/YR	0000	000
Warning power trouble on Power station	3	09	00	000	YM/YQ	0000	000
Battery not connected on Power station	3	11	00	000	YM/YQ	0000	000
Battery charger trouble on Power station	3	14	00	000	YP/YQ	0000	000
Battery charger disconnected on Power station	3	01	00	000	YP/YQ	0000	000
Short circuit output	3	12	00	000	YP/YQ	0000	000
Warning low battery on wireless detector	3	84	00	000	XT/XR	0000	000
General system alarm	1	30	00	000	BA/BH	0000	000
General system tamper	1	37	00	000	TA/TR	0000	000
Reset on partition	4	06	Part. n.	000	BC	0000	000
Chime on partition	0	00	Part. n.	000	00	0000	000
Negligence on partition	6	54	Part. n.	000	CD	0000	000
Loss of wireless zone	3	81	00	Zone n.	BS/BR	0000	Zone n.
Delinquency on partition	3	00	Part. n.	000	UT	0000	000
Arming refused on partition	4	54	Part. n.	000	CI	0000	000
Valid key	4	22	00	Key n.	JP	0000	Key n.
Valid code on keypad	4	22	00	Keypad n.	JP	0000	Keypad n.
Valid code	4	22	00	Code n.	JP	0000	Code n.
Valid Keyfob	4	22	00	Keyfob n.	JP	0000	Keyfob n.
Valid Key on key reader	4	22	00	Reader n.	JP	0000	Reader n.
False key event	4	21	00	Reader n.	DD	0000	Reader n.
Invalid code on keypad	4	21	00	Keypad n.	JA	0000	Keypad n.
Memory alarm on partition	1	30	Part. n.	000	BA/BH	Part. n.	000
Valid key on panel	4	22	00	000	JP	0000	000
Super key 1 on Keypad	0	00	00	Keypad n.	00	0000	Keypad n.
Super key 2 on Keypad	0	00	00	Keypad n.	00	0000	Keypad n.
Super key 3 on Keypad	0	00	00	Keypad n.	00	0000	Keypad n.
Alarm stop on partition	0	00	part. n.	000	00/00	Part. n.	000
Super Key on KeyFob	0	00	00	Keyfob n.	00/00	0000	Keyfob n.
Bypass zone	5	70	00	zone n.	BB/BU	0000	zone n.
Telephone line trouble	3	51	00	000	LT/LR	0000	000
Dialler action failed on telephone	3	50	00	Tel. Num. n.	VT/VR	0000	Keyfob n.
Installer Maintenance	0	00	00	000	00	0000	000

Table 18 Structure of the main Reporting formats supported by the System (continued ...).

EVENT	CONTACT ID			TYPE	SIA		
	CL.	CODE	GROUP		ZONE	1 st	2 nd
Timer Event	0	00	00	000	00/00	0000	000
Real time of zone	0	00	00	Zone n.	00/00	0000	Zone n.
Test	6	02	00	000	RP/UX	0000	000
Surveillance Maintenance on panel	0	00	00	000	00	0000	000
Reset on Panel	4	06	00	000	BC	0000	000
Chime on Panel	0	00	00	000	00/00	0000	000
Negligence on Panel	6	54	00	000	CD	0000	000
Delinquency on Panel	3	00	00	000	UT	0000	000
Valid code on panel	4	22	00	000	JP	0000	000
Valid keyfob on Panel	4	22	00	000	JP	0000	000
Super key 1 on panel	0	00	00	000	00/00	0000	000
Super key 2 on panel	0	00	00	000	00/00	0000	000
Super key 3 on panel	0	00	00	000	00/00	0000	000
Keyfob Super key on panel	0	00	00	000	00/00	0000	000
Arm Refused on panel	4	54	00	000	CI	0000	000
Exit time on Panel	0	00	00	000	00/00	0000	000
Entry time on Panel	0	00	00	000	00/00	0000	000
Autoarming warning on Panel	0	00	00	000	00/00	0000	000
False key on panel	4	21	00	000	DD	0000	000
Memory alarm on panel	1	30	Part. n.	000	BA/BH	Part. n.	000
Remote Command	0	00	00	Code n.	00	Code n.	000
Caller ID over GSM	0	00	00	Tel. Num. n.	00	Tel. Num. n.	000
GSM Absence	3	00	00	TBD	00	TBD	000
GSM Link Lost	3	00	00	TBD	00	TBD	000
GSM Receiver 1 LOST	3	00	00	000	00	0000	000
GSM Receiver 2 LOST	3	00	00	000	00	0000	000
GSM - Cellular Network Fault	3	00	00	000	00	0000	000
Arming refused on command zones	4	54	00	Zone n.	CI	0000	Zone n.
Arming refused on keyfob	4	54	00	Keyfob n.	CI	0000	Keyfob n.

Table 18 Structure of the main Reporting formats supported by the System.

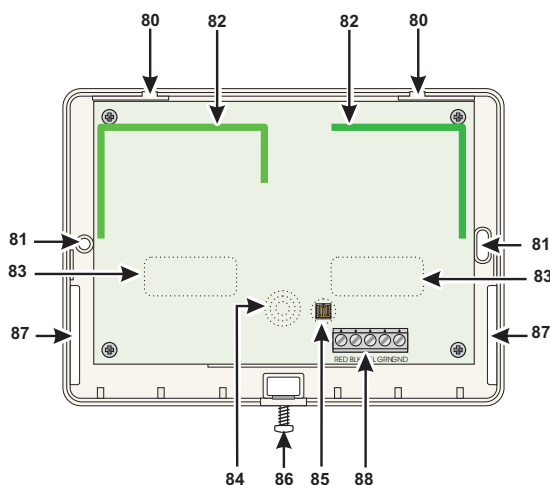

Figure 26 Receiver components.

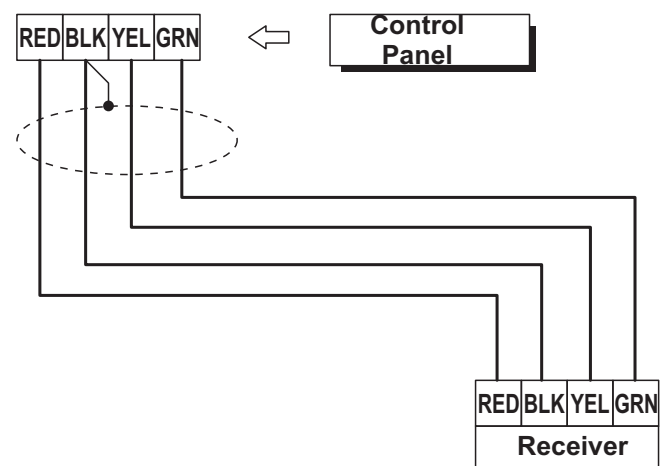

Figure 27 Connecting the Receiver to the Control panel.

Wireless Receivers

The **VRX32-433**, **VRX32-433EN** and **VRX32-868** Receivers will allow your system to manage up to 32 Wireless detectors and up to 16 Wireless keys. Please read this section to get an overall view of the steps involved in installing the Receiver. The term *Receiver* has been used in the parts where the functions and operating modes are common to all Receivers. However, in parts where the functions and operating modes differ, the respective Receiver has been specified.

■ Identification of Parts

The following Table describes the components of the Receiver (Figure 26).

N.	DESCRIPTION
80	Spring catch slots (2)
81	Anchor screw locations (3 x Ø 4.6 mm)
82	Antennas (2)
83	Microprocessors (2)
84	Wall tamper switch
85	Tamper button
86	Screws (2)
87	Wire entry (10 x 6.4 mm)
88	Terminal board

■ Choosing a Mounting Location

 Mount the Receiver and Wireless Devices after the placement tests.

Choose a place that is:

- Dry
- Central to the proposed placement of all Wireless Devices
- As close to the ceiling as possible
- Far from sources of interference such as: electrical noise (computers, televisions, electric motors in appliances, and heating and air-conditioning units), and large metal objects (heating ducts and plumbing) which may shield the antennas.

Ensure that no electrical wires run over the Receiver antennas. When mounting in a basement, place the module as high and as close to the underside of the first floor as possible. The range of the Receiver will be reduced if the unit is mounted below ground level.

■ Mounting the Receiver

When choosing the mounting location ensure that the mounting surface is flat, as uneven surfaces may impair proper functioning of the Wall Tamper Switch **84**.

1. Loosen the screw **86** (it is not necessary to remove it).
2. Press down on the tab **80** to release the backplate from the frontplate.
3. Lift the frontplate upwards to a 90° angle, then pull the frontplate away from the backplate.
4. Pull the connection wires through the wire entry **81**.
5. Place the backplate in the proposed placement, mark the screw positions **81** then drill the screw holes.

 **Be careful to avoid conduits and plumbing when drilling.**

6. Place the backplate in the proposed placement, pull the wires through the wire entry **87**, then secure the backplate to the wall (use anchor screws).
7. Complete the connections on the terminal board **88** (refer to “Connecting the Receiver”).
8. Push the frontplate spring catches into the slots on the backplate then push the bottom of the frontplate into place.
9. Fasten the screws **86**.

■ Connecting the Receiver

Connect the Receiver terminal **88** to the Control panel terminal (Figure 27).

 Use Shielded cable for the connection: connect one end of the shield to terminal **BLK** on the Interface, and leave the other end free. Do not use more than 50 metres total wire length.

■ Technical Specifications

Voltage	13.8 V _{DC}
Current draw	50 mA
VRX32-433 Frequency	433 MHz
VRX32-433EN Frequency	433 MHz
VRX32-868 Frequency	868 MHz
Dimensions	145x105x25
Weight	152 g

Broadcasting of the M-Touch Keypad Labels

The ABSOLUTA M-Touch keypad labels added to an existing installation must be synchronised with those of the Control Panel, as described below.

If there are multiple M-Touch keypads, the operation described below should be carried out only on one of the Keypads: the labels will be broadcasted to all M-Touch keypads connected to the Control Panel.

1. Press and hold the Keypad **Home** key for at least 3 seconds:



2. Press **Refresh Labels**:

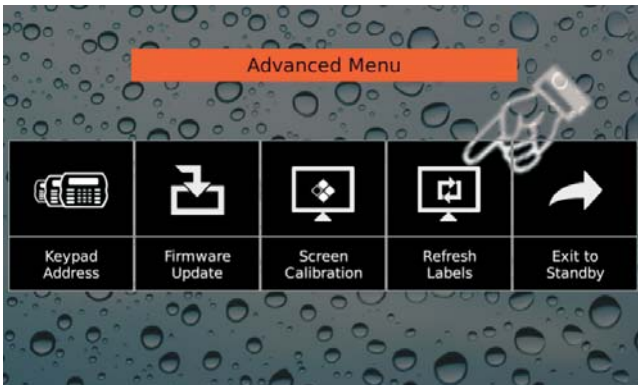

3. Press **OK** to confirm:

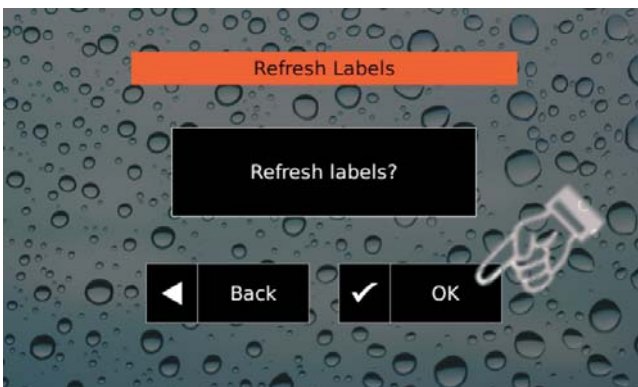

4. Wait for the labels to load:

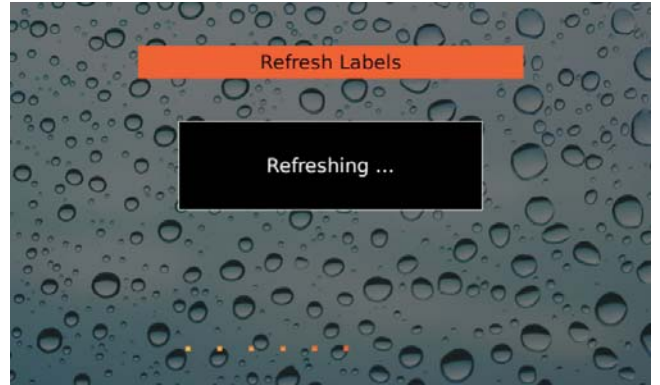

This may take a few minutes.

When the loading is complete, the display shows the following message:

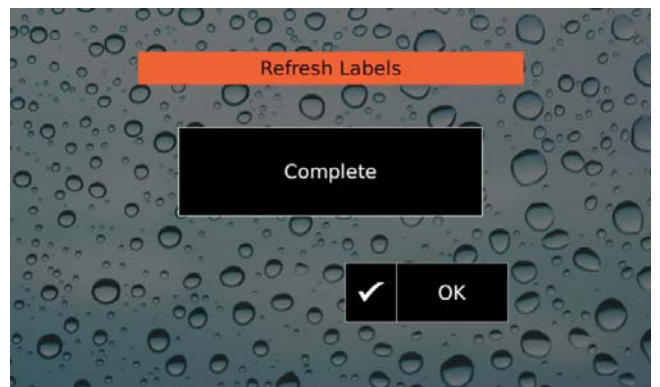

5. Press **OK** to go back to the Advanced Menu.

ABSOLUTA



Via Gabbiano, 22
Zona Ind. S. Scolastica
64013 Corropoli (TE)
ITALY
Tel.: +39 0861 839060
Fax: +39 0861 839065
e-mail: infobentelsecurity@tycoint.com
http: www.bentelsecurity.com

ABS-DOC/INT UK/FR ABSOLUTA DOC.MANUALS KIT



PFNKTB L6ABSDINT3

ISTISBLEKE	6.0	ABSOLUTA INSTALLER MANUAL
ISTUSBLEKE	6.0	ABSOLUTA USER MANUAL
ISTISBLFKE	5.0	MANUEL D'INSTALLATION ABSOLUTA
ISTUSBLFKE	5.0	MANUEL DE L'UTILISATEUR ABSOLUTA



BENTEL
SECURITY

MADE
IN
ITALY



ETIIMBL6ABSDINT 5.0